

Special
Issue

VYTÁPĚNÍ VĚTRÁNÍ INSTALACE

6 2021
VOL. 30

Journal of Heating, Ventilation, Sanitation

ISSN 1210-1389 / MK ČR E 6050

Special Issue of Journal of Heating, Ventilation, Sanitation

VVI Journal brings information:

- about the latest trends in heating, ventilation, air conditioning, cooling, humidification, dehumidification, hygiene, sanitation installation, measurement and control, lighting, noise, air quality, energy conservation, traditional and alternative energy sources at home and abroad;
- about new products, techniques and domestic or foreign technology for accurate and efficient operation of buildings with examples of practical use;
- about testing and measures improving quality of domestic production and enhancing sales of domestic products at foreign markets;
- about theoretical works dealing with new knowledge characteristics of new products, new computational methods and application of computer technology in the field of environmental engineering;

More information: www.stpcr.cz/en

Since 2014 the VVI journal is included
into the SCOPUS database

Scopus

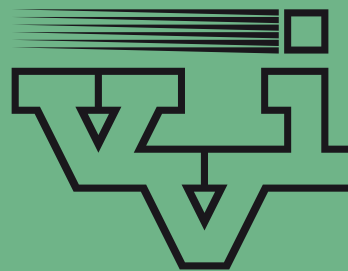

VYTÁPĚNÍ VĚTRÁNÍ INSTALACE

Odborný recenzovaný časopis Společnosti pro techniku prostředí

Člen Českého svazu VTS, člen REHVA,
asociovaný člen ASHRAE

REDAKCE

Vladimir.Zmrhal@fs.cvut.cz, tel.: 224 352 433,
homolova.vvi@gmail.com, tel.: 778 444 677.

PŘEDPLATNÉ

Česká republika: **SEND Předplatné**, s. r. o.,
Ve Žlíbků 77/1800, hala 3, 193 00 Praha 9,
tel.: 225 985 225, fax: 225 341 425,
send@send.cz, www.send.cz. Administrace:
Marek Rybenský, marek@send.cz.

Roční předplatné **250 Kč**, studenti **125 Kč**
včetně poštovného.

Slovenská republika: **MAGNET PRESS**,
SLOVAKIA s. r. o., P. O. Box 169, 830 00
Bratislava. Předplatné: predplatne@press.sk,
tel./fax: +421 267 201 930-1. Sídlo firmy
Šustekova 8, 851 04 Bratislava. Roční před-
platné **10,80 €**.

Volný prodej a zaslání na dobírku: Univerzitní
knihkupectví ČVUT, budova NTK, Technická 6,
160 80 Praha 6, vera.mikulkova@ctn.cvut.cz,
tel.: 224 355 003 nebo osobně v redakci.

Inzeráty přijímá a informace o podmínkách
inzerce podává Věra Jírová, tel.: 241 401 229,
603 180 596, vera.jirova.vvi@gmail.com nebo
Vladimír Zmrhal, vladimir.zmrhal@fs.cvut.cz,
tel.: 224 352 433.

Za obsah inzerce ručí objednatel.

Podávání novinových zásilek v ČR povoleno
Ředitelstvím pošt, Praha čj. NP 1727/1993 ze
dne 23. 3. 1993.

Jazyková korektura: Harvey Cook

Sazba: Josef Zima, js.zima@email.cz

STP je plátcem DPH. Expedice online.
ISSN 1210-1389. Registrace MK ČR E 6050.
© Společnost pro techniku prostředí

Časopis je zařazen
do mezinárodní
databáze SCOPUS.

Scopus

OBSAH	Strana	CONTENTS	Page
TEPELNÁ OCHRANA BUDOV		THERMAL PROTECTION OF BUILDINGS	
ČANDA, KOPECKÝ: Experimentální hodnocení střechy s plechovou střešní krytinou školní budovy v rozvojových zemích tropického klimatu	298	ČANDA, KOPECKÝ: Experimental Investigation of a Metal Sheet Roof for a School Building in Developing Countries in Tropical Climates	298
VNITŘNÍ PROSTŘEDÍ BUDOV		INDOOR ENVIRONMENT	
KABELE, VEVERKOVÁ, DVOŘÁKOVÁ: Analýza kvality vnitřního prostředí v domě vytvořeném 3D tiskem	303	KABELE, VEVERKOVÁ, DVOŘÁKOVÁ: Indoor Environmental Quality Analysis of 3D Printed House	303
LIS: Vnitřní prostředí v zateplených vzdělávacích budovách	311	LIS: Indoor Environmental Conditions in Thermally Retrofitted Educational Buildings	311
TEPELNÉ IZOLACE		THERMAL INSULATION	
KOVERDYNSKÝ: Praktické zkušenosti s kapilárně aktivní izolací pro rozvody chladu	319	KOVERDYNSKÝ: Practical Experience with Self-drying Insulation for Cold Piping	319
PŘÍPRAVA TEPLÉ VODY		HOT WATER PREPARATION	
LANGEROVÁ, VAVŘIČKA, ZAVŘEL: Analýza provozu ohřívače pro přípravu teplé vody a současnou podporu vytápění	324	LANGEROVÁ, VAVŘIČKA, ZAVŘEL: Combined Space and Water Heater Performance Analysis	324

Ing. Petr ČANDA
Ing. Pavel KOPECKÝ, Ph.D.

ČVUT v Praze, Fakulta stavební,
Katedra konstrukcí pozemních
staveb

Experimental investigation of a metal sheet roof for a school building in developing countries in tropical climates

Experimentální hodnocení střechy s plechovou střešní krytinou školní budovy v rozvojových zemích tropického klimatu

One of the key problems with buildings in tropical climates is the overheating of interior spaces due to an inappropriate building envelope. In the design of a school building in Zambia, possible roof assembly variants were assessed to find their thermal performance under real boundary conditions. For this purpose, a thermally insulated test box was built on the roof of the CTU university. In this way, six roof samples can be measured simultaneously in one test run. The roof assembly, made of a pure steel sheet with Zn coating, was considered to be the reference case. This case was then modified step-by-step for either a colour change, adding additional material layers, or ventilating a 2 cm thick air cavity. Reed boards were used as thermal insulation and unburnt earth boards served as the heat storage layers. In total, 18 roof assemblies were tested in three consecutive test runs (three-week periods between June and November 2020). The white paint and ventilated air cavity were proven to be the most effective solutions for reducing the heat gain through the roof. One roof assembly was selected for use in the school building project.

Keywords: thermal performance, metal sheet roof, developing countries, overheating, tropical climate

Jedním z důležitých problémů budov v tropickém klimatu je přehřívání interiéru z důvodu nevhodné obálky budovy. V návrhu školní budovy v Zambii byly hodnoceny možné varianty střešních souvrství pro získání poznatků o jejich tepelném chování za reálných okrajových podmínek. Pro tento účel byl zbudován tepelně izolovaný experimentální objekt na střeše budovy univerzity ČVUT. Šest skladeb střešních souvrství může být měřeno současně během jednoho testovacího cyklu. Souvrství s plechovou střešní krytinou opatřené běžnou zinkovou povrchovou úpravou bylo vybráno jako referenční varianta. Následně byla tato varianta postupně modifikována změnou barvy střešní konstrukce, přidáním dodatečných vrstev nebo provětrávané vzduchové mezery. Rákosové rohože byly použity jako tepelná izolace, desky z nepálené hlíny sloužily jako tepelně akumulativní vrstva. Celkově bylo testováno 18 variant střešních skladeb během třech cyklů měření (tři týdenní cykly, měření proběhlo mezi červnem až listopadem 2020). Bílá barva a provětrávaná vzduchová mezera se osvědčily jako nejučinnější opatření pro redukci tepelných zisků skladbou střechy. Jedno střešní souvrství bylo nakonec vybráno pro použití na projektu školní budovy.

Klíčová slova: tepelné chování, plechová střešní krytina, rozvojové země, tropické klima

INTRODUCTION

Projects for developing countries from foreign institutions are difficult tasks to manage. The author of the project must have knowledge about the state administration, laws and regulations, climate conditions, available building materials, local civil engineering market, and, most importantly, the community or society for whom it will be addressed. Architects and engineers who are unfamiliar with the local conditions risk designing buildings that will not function properly.

One of the most important aspects is the climate. The temperature, humidity, solar radiation, wind, and precipitation are factors that affect a building's performance and the comfort of its inhabitants. It is crucial in the building design that the building materials effectively counter the climate conditions. In recent decades, building materials in developing countries have changed. From conventionally used unburnt bricks, stones, timber logs and other materials, new materials have arrived. Metal sheets are becoming the prevailing option for roof coverings. Compared to the traditionally used reeds or straw, a metal sheet roof is more durable, it takes less time to build, has a longer lifespan, and does not require that much maintenance. However, it has two considerable disadvantages. It is significantly thermal and sound conductive, which can cause thermal and acoustic discomfort to the building's inhabitants.

The aim of this work is to compare the dynamic thermal performance of various roof assemblies under real boundary conditions to find the best version for the school project. The experiments were performed to monitor the thermal performance of the roof assemblies. By comparing different roof assemblies, which contain adjusted material layers to prevent the thermal gains, we can choose the best assembly for the project. This paper deals with the thermal performance of different roof assemblies with metal sheet roofs. A short-term experiment was performed with roof test samples placed on the roof of the Czech Technical University in Prague. In total, 18 individual roof assemblies from locally available building materials in Zambia were measured and compared.

THE KASHITU HIGH SCHOOL PROJECT

The non-government organisation Přátelé New Renato, based in Prague, Czech Republic and their sister organisation the New Renato Community Society from Kashitu, Zambia have a common goal to design and build a high school. For this purpose, the project of the new high school in Kashitu region in Zambia was created in the form of a diploma thesis published in 2019 [1] (see Figure 1).

The Kashitu High School is planned as a boarding school for 250 students. It is divided into several buildings and structures, such as lecture



Figure 1 Visualisation of the Kashitu High School

halls, laboratories, a dining hall, a library, and teacher offices. The school is also complemented with housing for teachers and volunteers. The total area of the high school with buildings, gardens, playgrounds and fields is approximately twelve hectares.

The climate conditions in Zambia can be classified as tropical or subtropical. The year can be divided into three periods. There is a warm and wet season with the majority of the rainfall with medium temperatures, lasting from November to April. Following this, there is a cool and dry period from May until July. In this timeframe, the temperatures change significantly during the day and the night with almost no rainfall. The third season takes place from August to October, which is known for rapid increases in temperature, where the dry period is at its peak. A graph with the monthly ambient air temperature and precipitation values can be found in Figure 2.

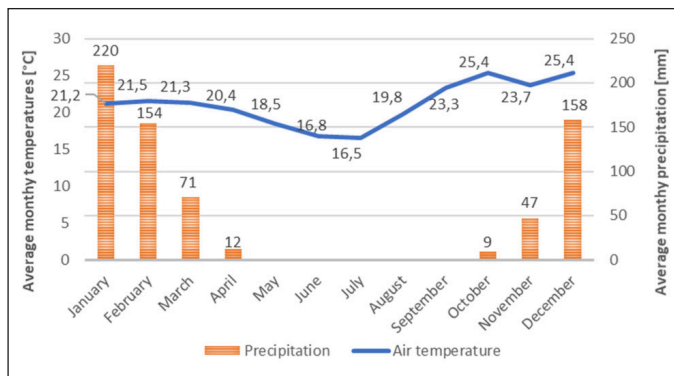

Figure 2 Monthly means of the ambient air temperature and precipitation sums in the targeted locality in Zambia, Data source: Meteornorm [2]

Table 1 Roof assemblies measured in the test runs (m.s. stands for metal sheet)

	S1	S2	S3	S4	S5	S6
First test run	unpainted m.s. (ref. case)	m.s. painted black	m.s. painted white	m.s. reed insulation board (20 mm)	m.s. unburnt earth board (22 mm)	m.s. vented air cavity (20 mm)
Second test run	S7 unpainted m.s. (ref. case)	S8 m.s. with single aluminium foil	S9 m.s. with aluminium foil in non-vented air cavity	S10 m.s. double reed insulation board (2x 20 mm)	S11 m.s. double earth board (2x 22 mm)	S12 m.s. vented air cavity (40 mm)
Third test run	S13 unpainted m.s. (reference case)	S14 m.s. painted white with vented air cavity (20 mm), reed insulation board and unburnt earth board	S15 m.s. vented air cavity (20 mm), reed insulation board, unburnt earth board	S16 m.s. vented air cavity (20 mm), reed insulation board	S17 m.s. vented air cavity (20 mm) and unburnt earth board	S18 m.s. reed insulation board and unburnt earth board

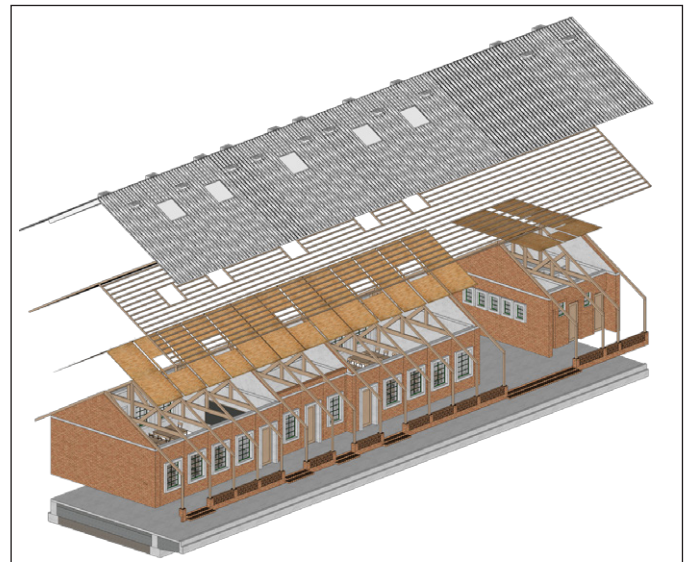

Figure 3 Construction system of the school buildings

The construction system is simply designed with stone foundations and concrete, the main walls are made from unburnt bricks stabilised by cement, and the roof construction is with a metal sheet covering (see Figure 3). The greatest challenge to the design was the roof construction.

The roof construction design has several important factors. It has to be resistant to all weather conditions. The construction must withstand all necessary loads from weight and weather and yet should be simple to build. The life span of the roof covering, which is part of the infrastructure of the school building, must be sufficiently long enough. Metal sheeting was chosen to be the building material that is most suitable for the architectural and functional purposes that can deal with the aforementioned problems.

SHORT-TERM THERMAL EXPERIMENTS

Several comparative studies were undertaken in previous years. The goal of most of them was to find a way to reduce the heat flux through the building envelope. In the case of the roof construction, we can find the expression of a cool roof, which indicates a passive cooling principle. Studies describing this thermal performance have been done in many countries [3]. Metal sheet roofing was explicitly used in measurements in Malaysia [4], India [5] and in Africa (Benin) [6]. Various passive cooling techniques were also examined on a roof's thermal performance [7]. The research attitude of this paper will be more complex, with many roof assemblies (see Table 1) to examine in a short-term experiment under real boundary conditions.



Figure 4 Experimental box with six roof samples in the first test run on the roof of CTU in Prague

To compare the thermal performance of the roof assemblies, an experimental test box was built (see Figure 4). The test box had a rectangular base with dimensions 6.2 m × 0.8 m. The construction was made from a wooden frame from spruce beams. The frame was sheathed with oriented strand board (OSB) (thickness of 15 mm) from the inside and wooden spruce planks (thickness of 22 mm) from the outside. Mineral wool insulation was placed between the wooden frame beams. The shed roof of the experimental box had a slope of 15° and was oriented in a south-west direction. The roof construction was made from wooden fibre board (thickness of 15 mm) and was divided into 6 different roof

samples for the experimental measurements. Every sample had an area of 0.9 m × 1.1 m and could be placed separately in the assembly with the designed roof layers.

Various roof assemblies were used (see Table 1). Experimental measurements were performed on three test runs. The first test run compared different physical principles, such as the thermal insulation, thermal mass, ventilated air cavity or the solar reflectance of the roof surface. Specific locally available materials in Zambia were selected to determine which one would be the most beneficial. In the second run, layers of different materials were doubled, and aluminium foil was used in two variants. The last test run examined the possibility of putting different layers on each other. The reference case in all three test runs was a simple metal sheet roof with a regular Zn coating (case S1). The test runs were performed in the timeframe from June to November, 2020. One test run lasted for approximately three weeks.

Various sensors were placed in the test samples. Thermocouples were placed between each material layer and on the bottom side of the metal sheet. Heat flux plates were fixed on the supporting wooden fibreboard from the interior in the same way for each roof assembly. To measure the exterior boundary conditions (temperature, relative humidity, global solar irradiance on the horizontal surface), a meteorological station was mounted on the pole next to the test box. A pyranometer was also situated on the roof to obtain global solar irradiance values on the plane parallel with the shed roof. All the data was taken in 5-minute time increments.

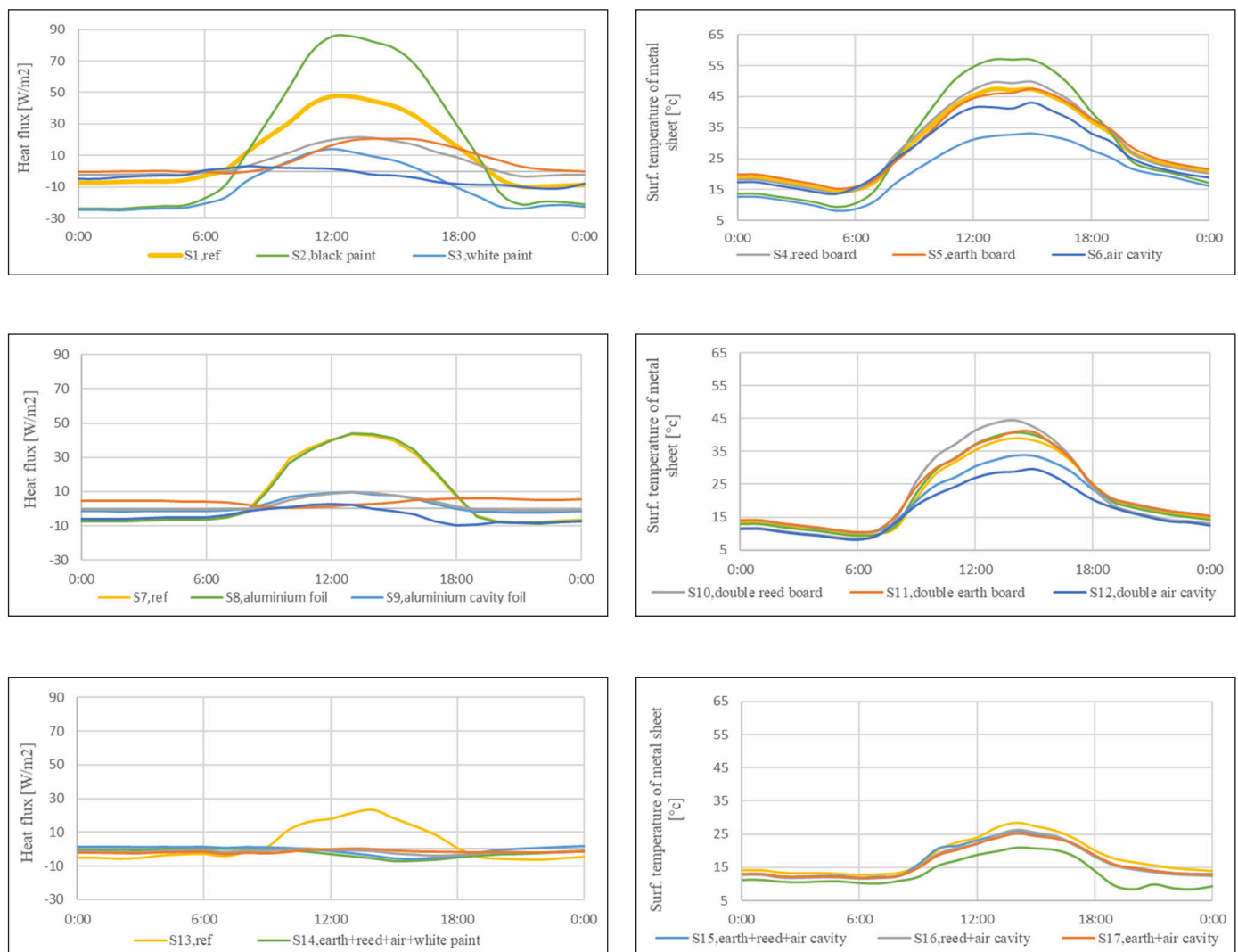

Figure 5 Measured data – heat flux through the internal surface (on the left) and surface temperature measured on the bottom side of the metal sheet (on the right) of the individual roof assemblies (S1-S17) measured on the selected days in three test runs.

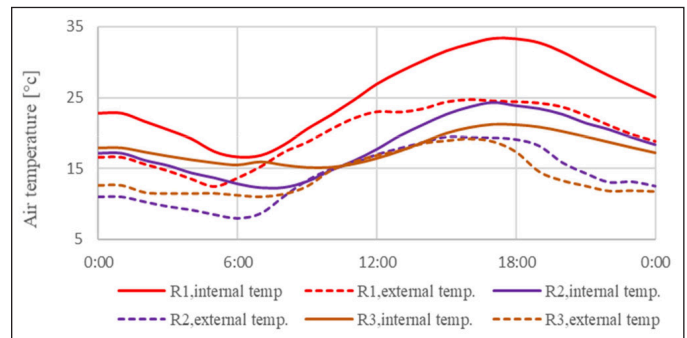
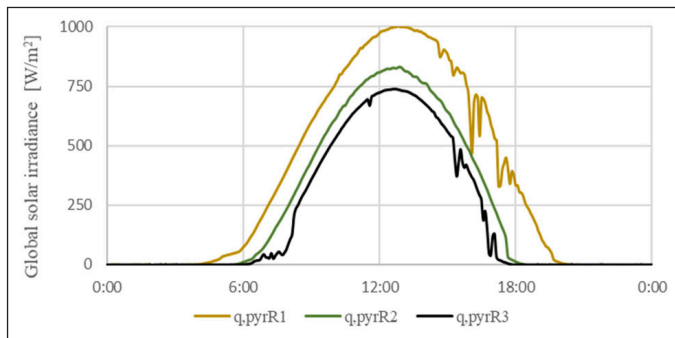

Figure 6 Global solar irradiance on the plane parallel with the shed roof (on the left) and the internal and external air temperature (on the right) measured on the selected clear-sky days in three test runs (R1 stands for the first test run, etc.).

MEASUREMENT RESULTS

A clear-sky day was selected from the individual test runs (see Figure 6 for the boundary conditions). The main benchmarks were considered to be values of the heat flux of the roof assembly and the surface temperature of the metal sheet (see Figure 5 for a comparison). A direct comparison between the individual test runs is not possible due to the different boundary conditions of the measurements.

The highest value of the peak heat flux and surface temperature of the metal sheet in the first test run was achieved by variant S1 with 85 W/m^2 , $57 \text{ }^\circ\text{C}$, while the white paint (S2) reduced the peak heat flux to 14 W/m^2 and surface temperature to $32 \text{ }^\circ\text{C}$. The peak heat flux for the reed board (S4) and earth board (S5) was similar for both variants at about 19 W/m^2 . The similar performance can be seen in the surface temperature. The heat flux profile for the roof assembly with a ventilated air cavity (S6) is interesting. The values of the heat flux were negative at some specific times of the day, which means that the heat flux was not oriented from the interior to the exterior, but in the opposite direction.

In the second test run, the highest heat flux of 45 W/m^2 was reached by the reference case (S7) and by the roof assembly with the aluminium foil placed in direct contact with the metal sheet and fibreboard (S8). The lowest peak heat flux was observed in the double ventilated air cavities with 3 W/m^2 . The heat flux of the aluminium foil case with an air cavity (S9) and the roof assembly with the double reed board (S10) was very similar. The double earth board (S11) led to a peak heat flux in the evening, demonstrating the effect of the thermal mass. The lowest values in the surface temperature of the metal sheet were achieved in the double air cavity case (S12) at $28 \text{ }^\circ\text{C}$.

The heat flux and surface temperature in the third test run was much flatter than in the previous runs. The differences between the individual roof assemblies were not that clear. This is mainly caused by the late timing of these measurements. Despite this fact, we can see that the roof assemblies with the air cavity, complemented with the reed board in one case (S15) and earth board in the other (S16) are practically the same in both measured characteristics. A slight reduction in the heat flux was measured in case S14 and S15. The lowest values in the surface temperature can be found in the case with the reed and earth board with the ventilated air cavity and metal sheet roof painted white (S14). The sensors were corrupted by a technology error in the last assembly (S18), so the values from them are not included.

DISCUSSION

The first test run demonstrated how the different building materials and physical principles can change the thermal performance of the

roof assembly. To increase the heat flux and surface temperature of the metal sheet, we can apply black paint on the metal sheet surface. With this adjustment, the heat flux values are almost two times higher compared to the reference case. On the other hand, white paint can reduce the heat flux almost four times in comparison to the reference case. The surface temperature of the white metal sheet achieved the lowest values. We can see that the reed board and earth board had a similar effect on both monitored characteristics. In both cases, the heat flux is reduced by half and the surface temperature is more or less the same. Lastly, an air cavity can be a strong provision for reducing the heat flux. The assembly with this addition has the lowest heat flux values and the second lowest ones on the surface temperature of the metal sheet. From this information, we can confidently conclude that the white paint and air cavity significantly reduced the heat gains through the roof assembly.

In the second test run, we included two roof assemblies with aluminium foil. The aluminium foil without any cavity did not change at all the thermal behaviour of the roof assembly. Only when the aluminium foil was placed in the middle of the air gap a difference in the thermal performance was present. By doubling the layer of the reed board, earth board and air cavity, we significantly lowered the thermal gains. Doubling the air cavity had the most noticeable effect, which achieved the lowest values in both monitored characteristics. When the double reed and earth boards were compared, the heat flux of the earth roof assembly was flatter than in the case of the reed boards, but the effect on reducing the overheating was almost the same.

The third test run demonstrated the layering of the previously used materials with adjustments to create the best roof assembly to reduce the heat flux. When the air cavity with the reed board is combined in one case and the air cavity with earth board in the second case, we can see that there is practically no difference in both scenarios. The same beneficiary influence can be seen when the reed board, earth board and air cavity were combined. The best roof assembly was constructed by combining all three of these layers with a metal sheet painted white. In both of the monitored characteristics (heat flux and surface temperature), it showed the lowest values.

CONCLUSION

The ventilated air cavity and white paint on the metal sheet were found to be the most effective provisions for lowering the thermal gains through the roof construction. A well-designed roof should avoid dark colours on the roof covering. If there is a possibility to use aluminium foil, it has to be placed in the middle of the air gap. The roof assembly with a reed board, earth board, ventilated air cavity, and metal sheet painted white has the biggest potential in being used in the real project of the Kashitu

High School in Zambia. An acoustics experiment on the noise attenuation of metal sheet roofs exposed to artificial rain is currently in preparation to complement the thermal experiments.

Acknowledgment. This work has been supported by the SGS Student Grant Competition, under supervision of the department of Architectural Engineering in the Faculty of Civil Engineering at CTU in Prague.

Contact: petr.canda@fsv.cvut.cz

References

- [1] ČANDA, Petr. *Design of the Kashitu high school: Návrh střední školy v Kashitu*. Praha, 2019. Diplomová práce. Katedra konstrukcí pozemních staveb, Fakulta stavební ČVUT v Praze.
- [2] *Meteonorm* [online]. Bern, Switzerland: Meteotest AG, 2019 [cit. 2021-10-31]. Available from: <https://meteonorm.com/>
- [3] RAWAT, Mohan a R. N. SINGH. A study on the comparative review of cool roof thermal performance in various regions. *Energy and Built Environment*. 2021, 2(4). ISSN 2666-1233.
- [4] KRÜGER, Eduardo, Djamila HARIMI a V.J. V.J. KURIAN. Assessment of Thermal Performance of Roof System with Galvanized Steel in East Malaysia. In: *PLEA2005. The 22nd Conference on Passive and Low Energy Architecture*. Beirut, Lebanon, 2005, s. 395-399.
- [5] BASKAR, Rajaram. Comparative study of different types of roof and indoor temperatures in tropical climate. *International Journal of Engineering and Technology (IJET)*. 2015, 7(2), 530-536. ISSN 0975-4024.
- [6] ADOUNKPE, Julien G., A. Emmanuel LAWIN, Clément AHOUANNOU, Rufin Ofin Lié AKIYO a Brice A. SINSIN. Modeling Solar Energy Transfer through Roof Material in Africa Sub-Saharan Regions. *ISRN Renewable Energy*. 2013, 1, 1-8. ISSN 2090-746X.
- [7] KACHKOUCH, Salah, Fatima AIT-NOUH, Brahim BENHAMOU a Karim LIMAM. Experimental assessment of thermal performance of three passive cooling techniques for roofs in a semi-arid climate. *Energy and Buildings*. 2018, 164, 153-164. ISSN 03787788.
- [8] ZINGRE, Kishor T., Man Pun WAN, Swee Khian WONG, Winston Boo Thian TOH a Irene Yen Leng LEE. Modelling of cool roof performance for double-skin roofs in tropical climate. *Energy*. 2015, 82, 813-826. ISSN 03605442.

prof. Ing. Karel KABELA, CSc.
Ing. Zuzana VEVERKOVÁ, Ph.D.
Ing. Pavla DVOŘÁKOVÁ, Ph.D.

Czech Technical University
in Prague, Faculty of Civil
Engineering, Department of
Indoor Environmental and
Building Services Engineering

Indoor Environmental Quality Analysis of 3D Printed House

Analýza kvality vnitřního prostředí v domě vytvořeném 3D tiskem

In 2020, the PRVOK residential sculpture was created using 3D printing from a concrete mix. In addition to its artistic mission, this endeavour serves to test how and whether modern technologies can be used in the construction of future buildings. The object is used for short-term public accommodation in a holiday resort in South Bohemia and, in addition, as a part of research projects, it is used for experiments to monitor its performance under different operating conditions. This paper summarises the results of a holistic assessment of the indoor environmental quality, carried out using the HAIEQ certified methodology. The HAIEQ methodology takes various parameters of the building into account to assess the current state and to suggest potential areas for improvement. The results show that the quality of the indoor environment is such a complex issue that the construction method alone does not have a major impact on the overall assessment.

Keywords: 3D printed building, indoor environmental quality, holistic IEQ assessment, intelligent building, ventilation, cooling, heating

V roce 2020 byla metodou 3D tisku z betonové směsi vytvořena obytná socha PRVOK. Kromě uměleckého poslání slouží tento počín k ověření, jak a zda lze použít moderní technologie při budoucí výstavbě budov. Objekt je využíván pro krátkodobé ubytování veřejnosti v rekreačním resortu v Jižních Čechách a vedle toho v rámci výzkumných projektů je využíván pro experimenty pro sledování jeho chování za různých provozních stavů. Tento článek shrnuje výsledky holistického hodnocení kvality vnitřního prostředí, provedené certifikovanou metodikou HAIEQ. Metodika HAIEQ zohledňuje nejrůznější parametry budovy, aby zhodnotila současný stav a navrhla potenciální oblasti, které by šly zlepšit. Výsledky ukazují, že kvalita vnitřního prostředí je problém natolik komplexní, že na jeho celkové hodnocení nemá pouze metoda výstavby zásadní dopad.

Klíčová slova: 3D tištěná budova, kvalita vnitřního prostředí, holistické hodnocení vnitřního prostředí, inteligentní budova, větrání, chlazení, vytápění

INTRODUCTION

In 2020, the Scoolpt art studio came up with an idea to create a residential sculpture, realised by 3D printing from a concrete mix. The authors, Michal Trpák, Ladislava Trpák, Jiří Vele and Kateřina Nováková, managed to find sponsorship support for this idea and, thus, the first Czech 3D printed house called PRVOK (=Protozoa) was created (Figure 1). After the installation of all the technical equipment together with an intelligent control system, the object was put into operation in the summer of 2020 [1]. Since spring 2021, it has been used for short-term accommodation for (up to) 2 people in a holiday resort on the shore of a South Bohemian pond.

The use of 3D printing technology to print a whole house is a major challenge, but a new innovation in the building process. It brings new issues not only in the field of actual production, as well as the static and the thermal properties of building structures, energy consumption in the operation and production, durability and environmental impact, but also in the quality of the indoor environment. Thanks to the authors' helpfulness, the building, besides acting as an interesting functional art object winning awards in many competitions, is also working as a living laboratory for testing and research. Therefore, in 2021, a comprehensive assessment of the quality of the indoor environment was carried out in PRVOK using the HAIEQ (Holistic Assessment of Indoor Environmental Quality) certified methodology developed by a team of the Department of Indoor Environmental and Building Services Engineering in the Faculty of Civil Engineering at CTU in Prague [2][5]. The HAIEQ assessment helps to identify the problem areas in terms of the IEQ (Indoor Environmental Quality) and to propose measures to solve them. In this case,

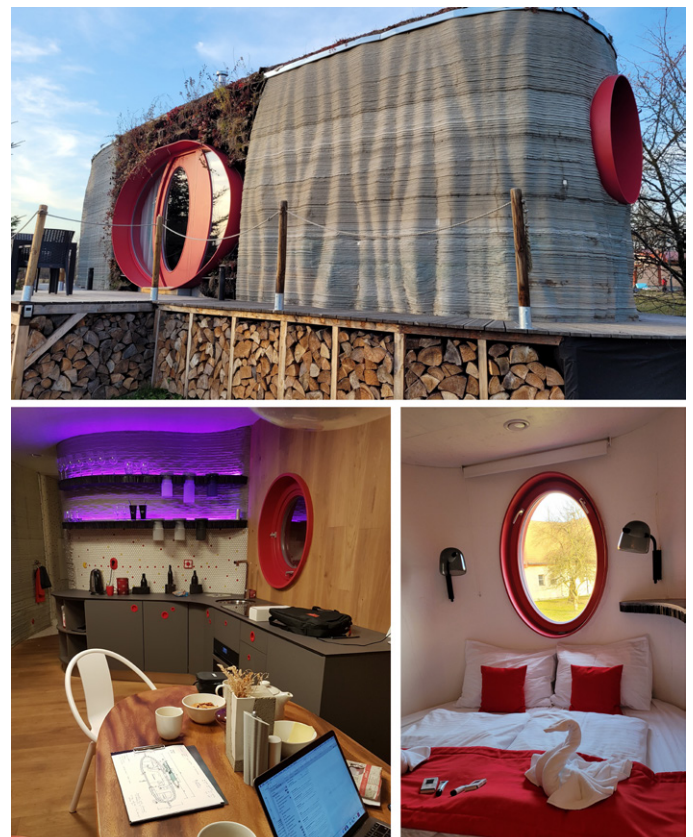

Figure 1. Residential sculpture PRVOK [photo authors]

it also works as a metric to find the gaps and express the benefits of the implementation of new intelligent management services in the field of indoor environmental quality management and building management in general within the TRIO research project, focused on the identification and development of new services for intelligent buildings [3].

HAIEQ ASSESSMENT METHODOLOGY

The indoor environment of a building consists of a set of physical, chemical, and social reactions between the users and the building, which includes phenomena affecting the technical, natural, and medical sciences [4]. To describe and quantify the parameters of the indoor environment of buildings, we commonly use a simplified model, describing and separately evaluating the individual components of the environment – the thermal comfort, air quality, acoustics, lighting, electromagnetic and other fields that co-create the final state of the environment.

The aim of this methodology is to create a complex holistic view of the assessed object in terms of all indoor environment factors. The HAIEQ methodology is based on a holistic approach to the integration of information about the building-technical design and interior, heating, cooling, ventilation, lighting, acoustics and electro-magnetic, -ionic, -static fields and ionising radiation, information about the real operation of the assessed building, based on data from measurements, a mathematical model, and a questionnaire. The output is a grouping of information expressing whether the object under assessment, in terms of each criterion, is solved at the level of the current state of knowledge or has the potential to improve the quality of the indoor environment, or whether there are significant deficiencies in terms of the quality of the indoor environment. The advantage of the methodology is the assessed method, which is not only intended to classify the IEQ in buildings, but to primarily indicate bottlenecks. In addition, a holistic approach helps to identify the causes of the problems and to better find the possible remedies. The information obtained can also be used to evaluate the SRI (Smart Readiness Indicator [6]).

The methodology contains four basic parts (Figure 2). The first part summarises the basic data about the assessed object and the assessor and the scope of the assessed parts of the object is defined, including the materials for the assessment (project documentation, local investigation, measurement and regulation records, own measurements, questionnaire). Data about the assessed zone with a focus on building technical solutions and interior, heating, cooling, ventilation, lighting, acoustics and electro-magnetic, -ionic, -static fields and ionising radiation are processed in the second part. Information about the real operation of the assessed object, based on data from measurements, a mathematical model, and a questionnaire is processed in the third part. The fourth and final part contains an assessment of the above-described state of the building solution in terms of eight criteria.

Each of the eight criteria contains 3-10 sub-criteria, where each is scored with grade 0 to 3. Grades are awarded based on the subjective assessment of the assessor, who has information about the object, measured data and, if possible, the result of the questionnaire. The evaluation is

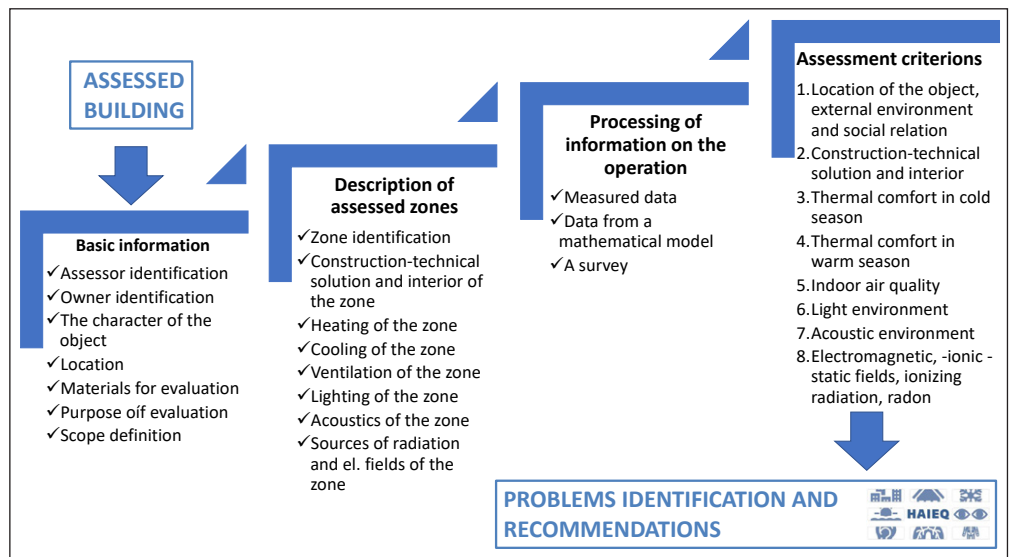

Figure 2. HAIEQ assessment methodology

intended to express the state of the assessed criterion. If there is not enough data for the assessment of the given criterion or its assessment is not relevant for the given object, this is evaluated as “0”. If there is sufficient data to assess the criterion and the analysis of the criterion, considering the user’s feedback, does not provide any recommendations for improving the current situation, this is evaluated as “1”. If the assessor suggests a measure leading to the improvement of the indoor environment, the criterion is evaluated as “2” or “3”. A rating of “3” indicates a serious problem in a given criterion that must be addressed immediately (e.g., a violation of the binding regulations, emergency state, malfunction or malfunctioning equipment). A rating of “2” indicates a condition that is acceptable, but can be improved and is desirable to do it. The proposed measure must be feasible for the given object and substantiated by justification (e.g., technical-economic analysis, expression of the benefit of the given measure, etc.). This assessment can, to some extent, especially when deciding between 1 and 2, be influenced by both the knowledge and experience of the assessor and the feedback from the users. Thus, for these criteria, the evaluation of some objects may be satisfactory (i.e., rating “1”, without comment), while for other similar objects, these criteria are commented on and measures leading to an increase in the quality of the indoor environment are proposed (a rating of “2”). The result of the questionnaire will play a role in this decision, which will express, for example, the user’s satisfaction with the current situation, even if it does not correspond to the current best state of knowledge (best practice).

The output of the methodology is a grouping of information expressing whether the assessed object is solved in terms of the individual criteria at the level of the current state of knowledge or has the potential to improve or if there are serious shortcomings in terms of the indoor environmental quality.

HAIEQ ASSESSMENT OF PRVOK

The assessment of the IEQ using the HAIEQ methodology is based on the assessment of data describing the architectural and construction design, the design of the technical systems and the operation.

Description of the building

PRVOK is a ground floor building, where, on the open space floor plan of 43 m², there is a bedroom, a toilet with a bathroom and a living area with a kitchenette (Figure 3).

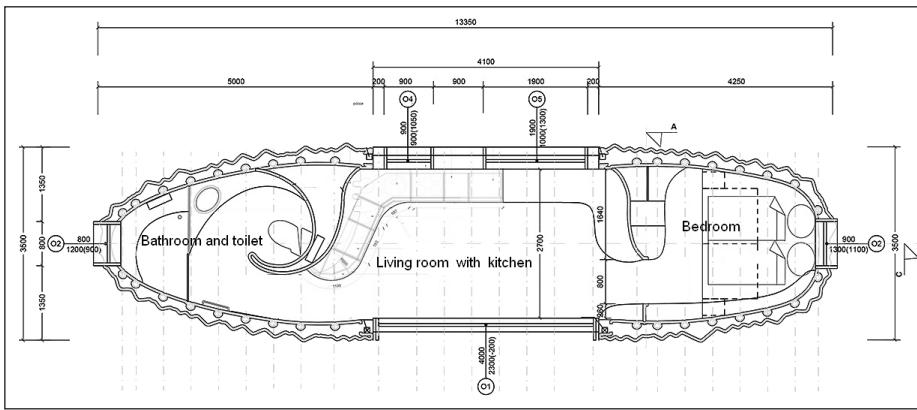

Figure 3. PRVOK floor plan [1]

The building is without foundations, the supporting bottom frame is metal, the perimeter structures (walls) are made of 3D printed concrete (bedroom and bathroom) in combination with a wooden structure (living area). The windows of the building are wooden frames with double glazing, the roof is flat green and in the central part of the building, vertical green walls are implemented in the exterior. The interior surfaces are made of 3D printed concrete, ceramic mosaic tiles, plaster, and wooden cladding.

The building has electric underfloor heating, a ceiling split air conditioning cassette unit with a heating output of 3.2 kW and a cooling output of 2.5 kW and a ventilation unit 150 m³/h (up to 500 m³/h) with a heat recovery exchanger providing equal pressure ventilation with the air supply to the bedroom, living area and shower and with the air exhaust from the bedroom, kitchen area and toilet.

The bathroom is equipped with a unique recirculation shower unit, a smart toilet with automatic operation and an electric storage water heater is installed for hot water generation. The building is connected to a grey water tank, with water recovery for flushing the toilet, and a black water tank with the possibility of the pumping and removal of sewage. Rainwater is used for the automatic irrigation of the green roof and facades. The object is connected to a mains water supply.

As part of the research project [3], in cooperation with an industrial partner, a master control system was installed in the building, which allows one to integrate all the control functions of the building operation, monitor the individual parameters, automate the control and, thanks to the remote access, perform service interventions. At the same time, the user has information about the current thermal comfort (air temperature and relative humidity) and the history of air temperatures in the bathroom, living area and bedroom. Information about the operating mode of the air conditioning and air handling unit (% of power), information about the use of lighting (in the living area including the intensity of the lighting and colour) and information about the current and total electricity consumption for a certain season is available. The user is also able to change the desired temperature in the interior of the bathroom, bedroom and living area, the setting of the power of the air handling unit (AHU) and the air conditioning unit and the desired temperature of the air supplied by the air conditioning unit. There is the possibility to switch the lighting on/off and to change the intensity and colour of the light in the living area.

MEASUREMENTS

For the PRVOK building, we had the design documentation, supplemented and verified by the actual condition during a detailed survey of the building (Figure 4) and data from the installed intelligent control sys-

tem. As was found in previous surveys, the data from the building control system needs to be validated – the industrial sensors used to control the different technical systems are not always calibrated with each other and so the data on the same quantity from different sensors varies within the tolerance of the sensor accuracy and the sensor location also has an influence. Therefore, the data from the control system were supplemented with several measurements of selected indoor environmental parameters.

The monitoring process started with one-off indicative measurements of the selected parameters (volatile organic com-

pounds (VOCs), CO₂, formaldehyde, negative ions) to get an overall picture of the state of the environment. Hand-held instruments were used for this purpose. At the same time, illuminance measurements and an analysis of the light spectrum of the artificial lighting system were carried out. These measurements were complemented by thermographic images of the envelope and floor heating to identify areas with thermal bridges. Then, additional medium-term (approx. 1 week) measurements of the flow velocity, the operative and air temperature, relative humidity and CO₂ concentration were carried out with a datalogger measurement set under different operating modes of the air handling equipment and with different occupancy. Installation of a long-term online monitoring system for the air temperature, relative humidity, CO₂ concentration, sound and barometric pressure levels followed. The results from the monitoring were processed and evaluated in the VISIEQ graphical output (Figure 5). All the data obtained formed a picture of the object, which was assessed and evaluated in the next step.



Figure 4. Verification of the air flow at the exhaust of the ventilation system [photo authors]

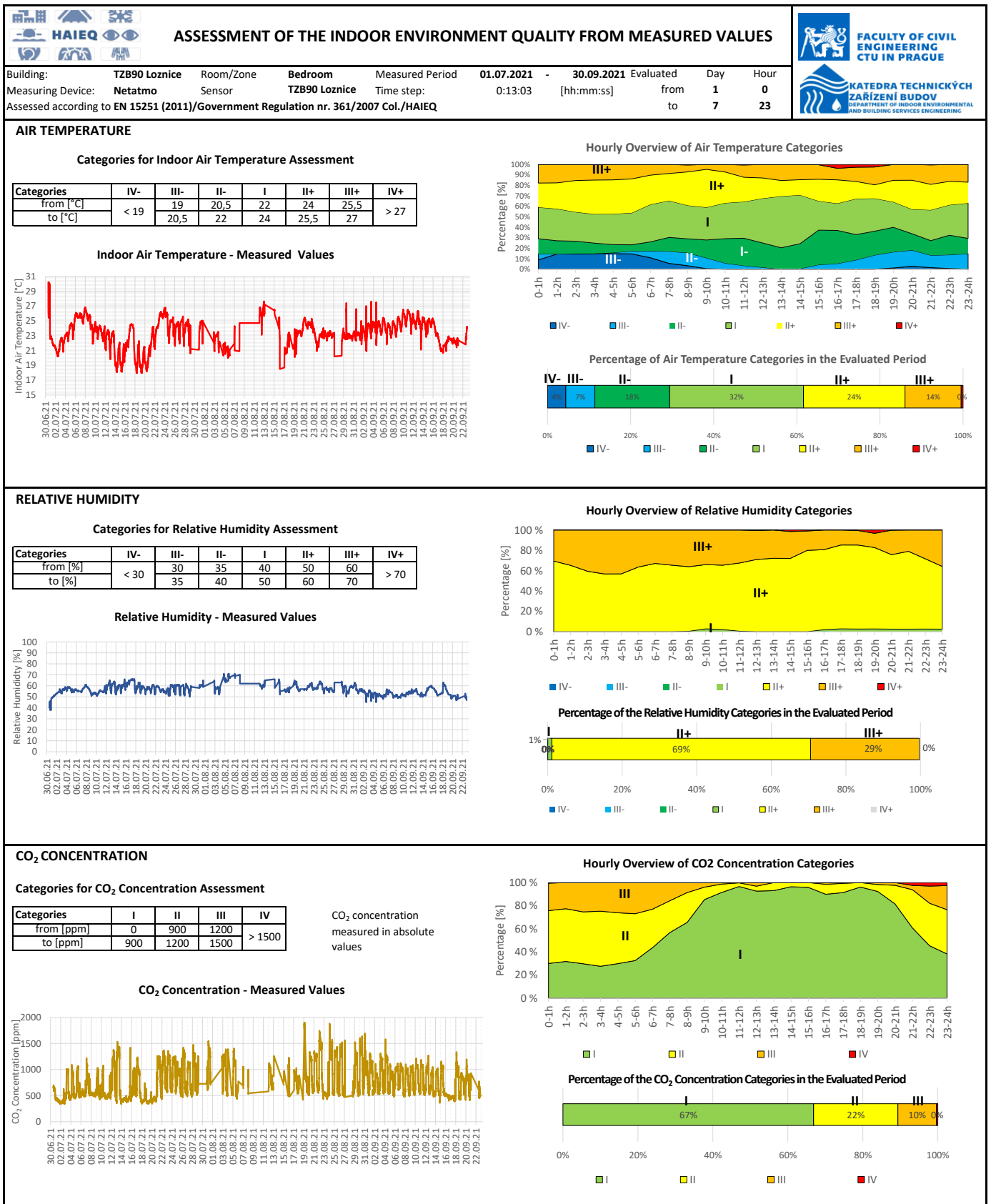

Figure 5. Evaluation of the measured values in a VISIEQ format

IEQ EVALUATION RESULTS AND DISCUSSION

The principle of the HAIEQ methodology, based on a 0-3 rating of a total of 48 sub-criteria grouped into eight areas, provides a holistic view of

the indoor environmental quality. The following tables summarise the results of the evaluation of each criterion and comments on the criteria rated 2 or 3.

Table 1 Evaluation of the locality and the location of an object in terms of the external environment and social relations (LS)

Criterion	Grade
LS1 Air quality (pollution)	1
LS2 Wind region	1
LS3 Noise from the surroundings	1
LS4 Orientation to cardinal points	1
LS5 Influence of heat island	1
LS6 Psychological perception of surroundings, interpersonal relationships	1
LS7 Risk of energy poverty	0
LS Average of the non-zero values LS1 to LS7	1
No comments	

Table 2 Evaluation of the building-construction and technical solution and interior (STI)

Criterion	Grade
STI1 Use of hazardous materials in the building structures (asbestos, etc.)	2
STI2 Risk of water vapour condensation on the structures (thermal bridges)	2
STI3 Use of hazardous materials for the equipment (formaldehyde, etc.)	2
STI4 Use of daylight	1
STI5 Active shielding and its control	2
STI6 Greenery in the interior	1
STI7 Visible defects and disorders (mould, leakage, cracks, poor surfaces, etc.)	2
STI8 Colour space solution	2
STI9 Layout solution, occupancy of the zone	2
STI10 Maintenance	2
STI Average of the non-zero values STI1 to STI10	1.8
Comments	
STI1: 3D printing from concrete is a new technology, and given the composition of the concrete mix, we recommend to monitor the indoor air quality.	
STI2: The details at the floor-wall interface show anomalies in terms of the temperature field distribution and are potential areas of condensation.	
STI3: The use of non-traditional materials (table made from subfossil oak 6000 years old, mined in Ostrava + resin, there are 220,000 strips of veneer on the shelves in the kitchen).	
STI5: External shading is not installed; internal shading is in the form of a roller shutter on the eastern window in the bedroom.	
STI7: Cracks in the structure caused by transporting the building. The rough surface of the 3D printed wall with no surface treatment can increase the risk of dust deposition and mechanical cleaning systems should be used to clean it.	
STI8: The colour scheme of the space is avant-garde, matching the character of the building. It may have a psychological impact on more conservative individuals.	
STI9: The layout of the social facilities without a door does not provide privacy.	
STI10: The technical design of the building service systems (recirculating shower, ventilation unit with heat recovery, air conditioning, rainwater irrigation, intelligent control system programming) requires qualified operators.	

Table 3 Evaluation of the thermal comfort in the cold season (TCW)

Criterion	Grade
TCW1 Choice of the heating system	1
TCW2 The ability of the heating system to adapt its operating mode in response to the users' needs with due regard to user-friendliness, maintaining a healthy indoor environment – e.g., individual temperature control, user feedback – subjective environmental quality assessment	1
TCW3 The ability of the heating system to report energy usage to the user	2
TCW4 The ability of the heating system to report the quality of the indoor environment in terms of the thermal comfort in the cold season to the user	2
TCW5 Summary of the thermal comfort assessment results for the cold season from the measurement/simulation (e.g., risk of overheating of the zone in the cold season due to heat gains, under-heating, etc.)	3
TCW6 Summary of the thermal comfort assessment results for the cold season from the questionnaire (if performed)	0
TCW Average of the non-zero values TCW1 to TCW6	1.8
Comments	
TCW3: The control system of the building provides the total energy use for all the systems, there is not any separate information about the energy use of the heating system.	
TCW4: Only the air temperature is reported, not the resulting temperature, which is insufficient in the case of radiant heating systems.	
TCW5: Large temperature fluctuations during the measurements occurred, probably caused by the ON/OFF control of the electric underfloor heating location and the storage layer of the floor. As a result, higher floor surface temperatures were also experienced.	

Table 4 Evaluation of the thermal comfort in the warm season (TCS)

Criterion		Grade
TCS1	Choice of the cooling system	2
TCS2	The ability of the cooling system to adapt its operating mode in response to the users' needs with due regard to user-friendliness, maintaining a healthy indoor environment – e.g., individual temperature control, user feedback – subjective environmental quality assessment	1
TCS3	The ability of the cooling system to report energy usage to the user	2
TCS4	The ability of the cooling system to report the quality of the indoor environment in terms of the thermal comfort in the warm season to the user	1
TCS5	Summary of the thermal comfort assessment results for the warm season from the measurement/simulation (e.g., risk of overheating of the zone in the warm season due to heat gains, under-heating, etc.)	1
TCS6	Summary of the thermal comfort assessment results for the warm season from the questionnaire (if performed)	0
TCS	Average of the non-zero values TCS1 to TCS6	1.4
Comments		
TCS1: Regarding the object design, the whole object is cooled in the case of a cooling requirement, it cannot be “zoned”, the object behaves as 1 zone (including the bathroom).		
TCS3: The control system of the building provides the total energy use for all the systems, there is not any separate information about the energy consumption of the cooling system.		

Table 5 Evaluation of the indoor air quality (IAQ)

Criterion		Grade
IAQ1	Choice of the ventilation system	1
IAQ2	The ability of the ventilation system to adapt its operating mode in response to the users' needs with due regard to user-friendliness, maintaining a healthy indoor environment – e.g., user feedback – subjective environmental quality assessment	3
IAQ3	The ability of the ventilation system to report energy use to the user	2
IAQ4	The ability of the ventilation system to report the quality of the indoor environment in terms of the indoor air quality	3
IAQ5	Summary of the indoor air quality assessment results from the measurement/simulation (if performed)	3
IAQ6	Summary of the indoor air quality assessment results from the questionnaire (if performed)	0
IAQ	Average of the non-zero values IAQ1 to IAQ6	2.4
Comments		
IAQ2: Ventilation system works in four modes with different air change rates depending on the chosen operation situation (0 %, 30 %, 60%, 100% of the total output of the AHU) without any monitoring of the IAQ parameters. No automatic control of the ventilation system output.		
IAQ3: There is just the information about the total energy use of the whole building available, not only for the ventilation system itself.		
IAQ4: No measurements of the IAQ parameters are taken, so they are not available to the users.		
IAQ5: Based on the seven-day measurement of the CO ₂ concentration, it can be stated that, 80% -90% of the time, the IAQ is in category II (according to EN 16798-1). There were several rare episodes when the CO ₂ concentration reached values above 1500 ppm or even above 4000 ppm. However, it can be due to more people present in the building than it is designed for.		
An orientation measurement of the formaldehyde performed within one hour detected its concentration. The average measured concentration was 0.2 ppm and this concentration is four times larger than the limit concentration for residence rooms coming from the Czech standard (Decree No. 6/2003 Coll.). This situation can be due to the new and unconventional equipment of the building, though it is supposed to decrease in time. Nevertheless, an increased air change rate may help.		

Table 6 Evaluation of light comfort (LC)

Criterion		Grade
LC1	Choice of the lighting system	1
LC2	The ability of the lighting system to adapt its operating mode in response to the users' needs with due regard to user-friendliness, maintaining a healthy indoor environment – e.g., regulation of the intensity and spectrum of the light sources in the workplace, user feedback – subjective environmental quality assessment	2
LC3	The ability of the lighting system to report energy usage to the user	2
LC4	The ability of the lighting system to report the quality of the indoor environment in terms of the light comfort	2
LC5	Summary of the light comfort assessment results from the measurement/simulation (if performed)	1
LC6	Summary of the light comfort assessment results from the questionnaire (if performed)	0
LC	Average of the non-zero values LC1 to LC6	1.6
Comments		
LC2: Although the system of LED luminaires and strips offers and allows great variability in the colour and intensity, the creation of lighting scenes and their control requires user effort and is not intuitive.		
LC3: The control system of the building provides the total energy use for all the systems, there is not any separate information about the energy consumption of the lighting system.		
LC4: There is no information about the quality of the light environment in the building provided to the user.		









Table 7 Evaluation of the acoustic comfort (AC)

Criterion	Grade
AC1 Sources of noise and measures to eliminate them	2
AC2 The ability of the system to report the quality of the indoor environment in terms of the acoustic comfort	2
AC3 Summary of the acoustic comfort assessment results from measurement/simulation (if performed)	1
AC4 Summary of acoustic comfort assessment results from the questionnaire (if performed)	0
AC Average of the non-zero values AC1 to AC4	1.67
Comments	
AC1: Due to the open space, sounds spread throughout the space (e.g., sounds from the toilet and kitchen area). A door between the living room and bathroom may help to solve this problem.	
AC2: There is no information about the quality of the acoustic environment in the building provided to the user.	

Table 8 EC Evaluation of the electro-magnetic, -ionic, -static fields, ionising radiation

Criterion	Grade
EC1 Sources of electro-magnetic, -ionic, -static fields, ionising radiation and measures to eliminate their negative effects	0
EC2 Summary of the assessment results from measurement/simulation (if performed)	0
EC3 Summary of the assessment results from the questionnaire (if performed)	0
EC Average of non-zero values EC1 to EC3	0
Comments	
Not enough information for assessment. Despite the fact that the electric devices installed in the building individually meet the limits for electromagnetic fields (kitchen appliances, hot water tank, air conditioning unit, LED light strips, electric underfloor heating, smart toilet, shower, intelligent control with wireless data transmission), it is recommended to provide measurements and an analysis of the electromagnetic fields and determine whether there is an increase in their intensity above the permissible limits.	

Table 9 Summary evaluation and potential for improvement

Zone:			"PRVOK"	
Evaluation criteria			Evaluation	Potential for improvement
	LS	Locality and place of the object in terms of the external environment and social relations	1,000	0%
	STI	Building - construction and technical solution and interior of the evaluated zone	1,800	40%
	TCW	Thermal comfort for the cold period	1,800	40%
	TCS	Thermal comfort for the warm period	1,400	20%
	IAQ	Indoor air quality	2,400 !	70%
	LC	Light comfort	1,600	30%
	AC	Acoustic comfort	1,667	33%
	EC	Electro-magnetic, -ionic, - static fields, ionizing radiation	0	N/A

CONCLUSION

The HAIEQ assessment methodology allows a comprehensive holistic view of the assessed building in terms of the individual indoor environmental quality factors and their assessment. The method helped to identify problems and showed potential areas for improvement.

Summarising the findings obtained from the analysis of the investigated object, we can say that 3D printing technologies brings new opportunities, especially in the freedom of the building's shape and enables the realisation of buildings with a distinctive architectural expression. The only problem area related to the structure was revealed by the thermal imaging camera, which identified potential condensation points at the floor-wall interface.

In terms of the quality of the indoor environment, the greatest potential for improvement was in the area of the air quality. Due to the building's small volume and the specific layout, taking the measured values into account, it became clear that it would be advisable to control the heating, ventilation, and air conditioning according to the CO₂ concentration, humidity and to consider controls according to the VOCs. In addition, repeated formaldehyde measurements, which may be produced by the new equipment and can be expected to decrease in concentration during operation, should be made. The rough internal surface of the 3D printed structure requires more intensive maintenance and, if neglected, increased airborne dust concentrations can be expected. The specific layout also causes acoustic problems between the different functional areas - bedroom, living area and sanitary facilities.

Our main objective was to test and evaluate a master control system that, in its basic configuration, enables the required functions and provides most of the necessary information. The subject of our further research and development is now the creation and testing of an advanced user interface that allows the user to modify the environment in a user-friendly way, while obtaining feedback on its actual quality and energy performance.

The IEQ rating of this 3D object is not different from that of a conventionally constructed building. Most of the critical areas are not directly related to the 3D printing technology, but rather to the architectural design and operational management of the building.

Contact: kabele@fsv.cvut.cz

Acknowledgment. This project was implemented with financial support from the state budget of the Czech Republic through the Ministry of Industry and Trade in the TRIO-FV40183 programme in cooperation with the company Brandtech.

References

- [1] TRPÁK, M., NOVÁKOVÁ, K., VELE, J., TRPÁK, L., JIŘÍČEK, M., KLEJNA K. *Jak Prvok přišel na svět* [online]. Dostupné z: <https://www.scoolpt.com/pribeh-prvoka/>
- [2] KABELE, K., Z. VEVERKOVÁ, and M. URBAN. *Metodika hodnocení kvality vnitřního prostředí v budovách s téměř nulovou spotřebou energie*. Applied Certified Methodology. 2019.
- [3] KABELE, K. Výroční zpráva projektu TRIO – FV40183 Rozšíření systému řízení produktu inteligentní dům. Annual Report. Brand-Tech, 2019. Report no.1
- [4] BLUYSSSEN, P., M., 2009. *The Indoor Environment Handbook How to Make Buildings Healthy and Comfortable*. United Kingdom: Earthscan Ltd. ISBN: 13: 9781844077878
- [5] KABELE, K., Z. VEVERKOVÁ, and M. URBAN. Methodology of IEQ assessment in energy efficient buildings. In: *Windsor 2020 Resilient Comfort*. Windsor, 2020-04-16/2020-04-19. Witney: Ecohouse Initiative Ltd., 2020. p. 861-876. ISBN 978-1-9161876-3-4. Available from: <https://windsorconference.com/proceedings/>
- [6] VERBEKE S., WAIDE P., BETTGENHÄUSER K., USLAR M.; BOGAERT S. *Support for setting up a Smart Readiness Indicator for buildings and related impact assessment - final report*. 2018. Brussels

Indoor environmental conditions in thermally retrofitted educational buildings

Vnitřní prostředí v zateplených vzdělávacích budovách

One way of increasing the energy efficiency of buildings is through projects related to their thermal retrofitting. Activities related to the reduction of the energy consumption of buildings should be correlated with the improvement of the indoor environmental conditions. However, errors in the implementation of an energy efficiency programme may result, inter alia, in the deterioration of the indoor air quality and the appearance of the sick building syndrome phenomenon. The paper presents the results of studies carried out in several educational buildings before and after thermal retrofitting. The studies included the energy performance of the buildings and the selected parameters of the interior microclimate. This analysis was carried out in order to assess the impact of energy-saving measures on the conditions of the indoor microclimate. During the study, negative symptoms, identified with the long-term usage of rooms in the buildings, were observed. It was found, in many cases that the commonly used gravity ventilation is not able to ensure the proper air quality in rooms, and the carbon dioxide concentration recorded in the tested rooms exceeded the applicable standards.

Keywords: thermal retrofit, educational buildings, indoor microclimate parameters, indoor air quality, sick building syndrome

Jedním z prvků zvyšujících energetickou účinnost budov jsou projekty související s jejich tepelnou modernizací. Akce související se snížením spotřeby energie budov by měly být ve vzájemném vztahu se zlepšením podmínek vnitřního prostředí. Chyby při provádění programu energetické účinnosti však mohou mít mimo jiné za následek zhoršení kvality vnitřního ovzduší a výskyt syndromu nemocných budov. Příspěvek prezentuje výsledky testů provedených v několika vzdělávacích budovách před a po tepelné modernizaci. Výzkum zahrnuje spotřebu energie na vytápění budovy a vybrané parametry vnitřního mikroklimatu. Tato analýza byla provedena za účelem posouzení dopadu opatření na úsporu energie na podmínky vnitřního mikroklimatu. Během výzkumu byly také pozorovány příznaky nesprávného fungování organismů uživatelů pokojů v budovách, které identifikovali při dlouhodobém pobytu v daném prostředí. Bylo zjištěno, že v mnoha případech není běžně používaná gravitační ventilace schopna zajistit správnou kvalitu vzduchu v místnostech a koncentrace oxidu uhličitého zaznamenaná ve vybraných místnostech překračuje příslušné normy.

Klíčová slova: zateplení budov, vzdělávací budovy, mikroklimatické parametry, kvalita vnitřního vzduchu, syndrom nemocných budov

INTRODUCTION

The quality of the indoor environment is one of the basic issues covered in most guidelines for a building's the energy assessment of a building when designing sustainable and low-energy buildings. According to the European Union directive on the energy performance of buildings, it is important not only to improve the energy efficiency of buildings, but also to define the conditions for classifying objects in terms of the internal microclimate requirements [3, 4]. Energy-saving measures focusing only on the thermal insulation of building envelopes and the tightness of windows and doors often result in the deterioration of the quality of the interior microclimate. The excessive tightness of buildings usually leads to the improper operation of gravity ventilation systems and deterioration of the indoor air quality [17, 28, 32, 36]. Poor indoor air quality is usually the cause of the sick building syndrome. Attention has also been drawn to the relationship between the quality of the internal environment and growing sickness absences and their high economic cost [10, 29, 37, 40]. The requirements for shaping the proper conditions of the indoor environment in buildings should, therefore, be given priority over the requirements of energy savings due to the need to ensure, above all, appropriate conditions for people to stay in closed rooms. The approach to a whole building thermal retrofitting must, therefore, take various factors into account and balance them, such as energy efficiency level, building materials used and human health, in order to avoid the in-

appropriate effects of wrong practices in this area [28, 41]. EU directives oblige member states to take actions related to supporting thermal retrofit investments [1]. Long-term renovation strategies developed by different countries aim to improve the energy efficiency of the construction sector and show the way how to achieve a multi-scale and deep building renovation. The effect of thermal retrofitting is primarily to save the final energy in buildings and to reduce the carbon dioxide emissions and particulate matter [15, 16]. Energy requirements are defined differently in different countries, and often different technologies and solutions are used in the thermal retrofitting of buildings. Improving the energy efficiency, which should also translate into an improvement in the quality of the indoor environment in thermal retrofitted buildings with various types of use, requires, in each case, the development of a detailed concept, as the modification of the building structure and technical infrastructure alone is not always sufficient, e.g., the way that low-energy buildings are used should not only take their purpose into account, but also require appropriate behaviour on the part of their users [5, 28, 30].

The problem of the quality of the indoor environment in relation to the well-being and health of its users and the rationalisation of energy consumption has also recently gained importance in relation to educational buildings. Apart from residential buildings, educational buildings are an important environment in which children and young people spend a lot of time. The influence of the environment, especially on preschool and

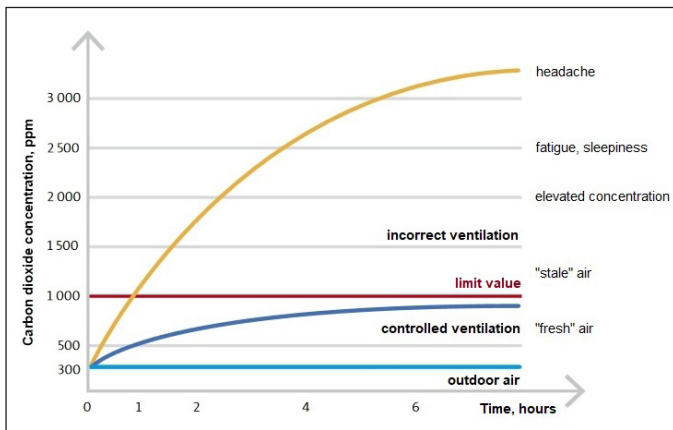

Fig. 1. The impact of ventilation on the CO₂ concentration and the user's feelings [31]

school-age children, is intensified due to the greater sensitivity of their not yet fully formed organisms and may cause defects in their development. Several conducted studies showed very poor air quality in educational rooms, which may lead to a deterioration of the well-being or even illness, and, therefore, to school absences and breaks in learning. At present, a high incidence of allergic diseases can also be observed in students [6, 13, 18, 22, 33, 34]. In the studied educational rooms, particularly high carbon dioxide concentration levels were also recorded for most of the school classrooms with the gravity ventilation system commonly used in Poland [12, 23, 27]. Although carbon dioxide is not considered a poisonous air pollutant, high levels of this concentration inside buildings can have negative effects on the building's users. Among the most frequently reported health problems mentioned are: fatigue, sleepiness, headaches, malaise and difficulty in concentration (Fig. 1).

There are certain carbon dioxide thresholds that are considered a measure of air quality. The content of CO₂ in clean atmospheric air is about 350-450 ppm. It is assumed that the concentration of CO₂ in the air in the room should not exceed 1000 ppm. At the level of 2000 ppm, poor air quality and sleepiness are observed, at values of 2000-5000 ppm, headaches are possible. Values above 5000 ppm can lead to discomfort and a rapid heart rate, and respiratory problems occur above 15,000 ppm.

An equally important aspect of the quality of the environment in educational rooms is ensuring appropriate conditions for mental work. Appropriate interior conditions affect not only the ability or willingness to learn, but also the efficiency and quality, as well as the final results [2, 7, 8, 38]. On the basis of our own research conducted in nursery school buildings, it was found that an increase or decrease in the air temperature in the rooms contributed to the marked weakening in the ability of the

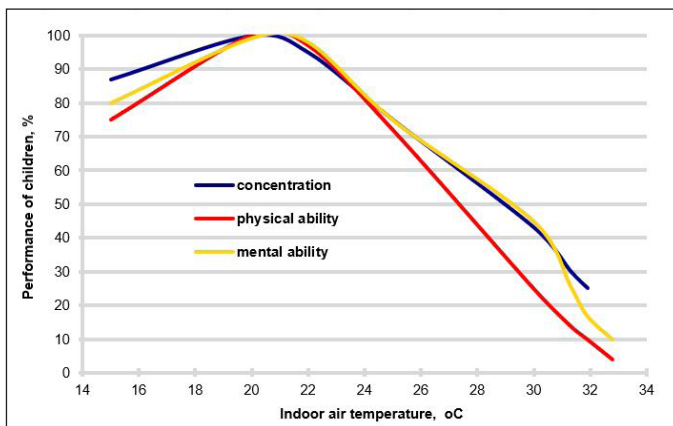

Fig. 2. The physical and mental ability of children as a function of the indoor air temperature

examined people to perform efficiently, especially mental work (Fig. 2). At high temperatures, children showed greater willingness for physical effort than adults.

The energy efficiency of educational buildings is, of course, an important issue in the era of rationalising energy use and reducing the negative impact of buildings on the environment, but it is primarily important that thermal retrofitting leads not only to lower operating costs of the buildings or reducing the emission of harmful substances into the atmosphere from the combustion of non-renewable fuels, but also to improve the quality of the interior environment. Knowledge of the issues related to shaping the quality of the indoor environment is crucial in the thermal retrofitting of buildings, therefore, it is always necessary to develop and monitor cost-effective, highly efficient and minimally invasive solutions to ensure obtaining not only the appropriate energy, economic and ecological effects, but also functional ones too [14, 19, 20, 25, 42].

PURPOSE, SCOPE AND METHODS OF THE STUDY

The World Health Organization has confirmed that many symptoms of diseases that people complain about are associated with the quality of the indoor environment in which they visit, reside in or work in [39]. The long-term impact of unfavourable environmental conditions may cause or intensify a person's poor health. Since people spend a lot of time indoors, buildings should, therefore, be constructed with the aim to reduce any negative impacts on the user. The main problem in the group of existing educational buildings is the lack of adequate thermal insulation of the building envelope, low efficiency of the technical systems and numerous defects and faults, e.g., warped and leaky windows. This results in significant energy losses and high operating fees, overburdening the already slim school budgets. However, an equally important problem revealed during studies conducted in educational buildings turned out to be the improper air quality in their interiors and the negative impact on the users [6, 13, 18, 22, 33, 34]. The impact of the interior environment on children and young people due to the long-term usage of the building is especially important due to the much greater sensitivity of their not yet fully formed organisms, as well as the impact of the air quality not only on their well-being and health, but also on their ability to do mental work. It seems that including this group of buildings in thermal retrofit programmes should bring measurable benefits resulting from the reduction in the energy consumption and, at the same time, improvement in the indoor environmental quality. However, it turns out that this is not always the case. Errors made both during the energy audit, which is the basis for thermal retrofitting activities, and during the implementation of the selected thermal retrofit variant, may lead to a lack of improvement or even the deterioration of the indoor conditions [9, 21, 24, 26, 35, 41]. Therefore, it is so important to carry out a precise audit analysis before undertaking thermal retrofitting. Taking the need to increase the energy efficiency of educational buildings into account, and, at the same time, to ensure the proper environmental conditions in their interiors, it was decided to carry out an assessment of the impact of thermal retrofit measures on the interior microclimate conditions in this group of buildings.

The evaluation covered several educational buildings that were subjected to thermal retrofitting, located in the city of Czestochowa, which is situated in southern Poland, in the Silesian Voivodeship. Information about the buildings was collected before the thermal retrofit works were carried out in them, specifically the material and construction solutions and technical systems, as well as an analysis of the improvements used in the thermal retrofit of the buildings, and the energy characteristics of the buildings before and after the thermal retrofitting. Measurements of selected interior microclimate parameters were carried out in the buildings during the heating season before thermal retrofitting, and then in

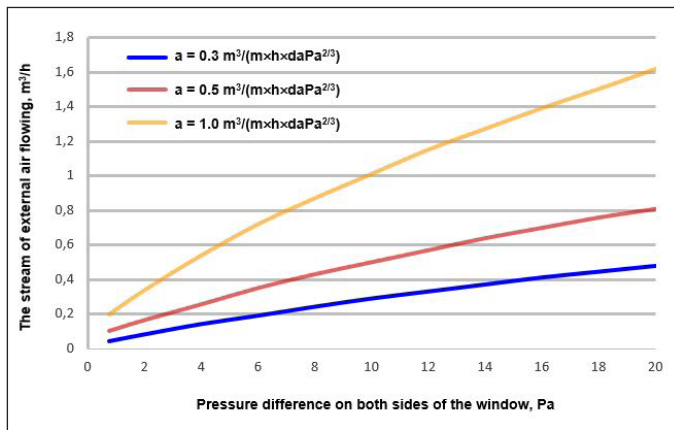

Fig. 3. The external air inflow to the rooms at different values of the air infiltration coefficient “a” and the pressure difference on both sides of the window

the same period after the completion of the thermal retrofit works under similar temperature and humidity conditions outside. During the observation, factors influencing the quality of the internal environment as well as the well-being of the users were taken into account.

The research related to the assessment of the interior environment was carried out in typical classrooms where lessons were conducted while the measurements were being taken. Most of the classrooms in the individual buildings were included in the research. The rooms were located on the first and second floors. The average size of a classroom was 58 m², with an average of 15 people in the classroom. All the rooms, in which the research was conducted, were rectangular in shape with windows located only on one of the long sides on the eastern, western or southern facing walls. The glazing of the façade in the rooms was 49% on average, the maximum recorded value of the glazing was 69%. All the rooms were equipped with gravity ventilation, the ventilation ducts were unobstructed. The windows in all the rooms were plastic having a declared infiltration coefficient before the thermo-modernisation higher than 0.5 m³/(m·h·daPa^{2/3}), which should ensure an adequate inflow of external air to the rooms. The estimated stream of external air flowing into the rooms through 1 m of the window slots length at different values of the air infiltration coefficient “a” and the pressure difference on both sides of the window is shown in Fig. 2.

During the measurements, the air temperature (ϑ_a) and relative air humidity (φ_a) outside were recorded. In the educational buildings, the air temperature (ϑ_i), relative air humidity (φ_i) and air flow velocity (v) were measured inside the rooms and, in some rooms, the ambient radiation temperature (ϑ_r) and the carbon dioxide concentration level were recorded using standard, calibrated measuring devices. The temperature measurement interval was from 0 to 60 °C, the resolution is 0.1 °C and accuracy is ± 0.6 °C. The relative humidity range is 0.1 to 99.9%. The relative humidity resolution is 0.1% and accuracy $\pm 3\%$. The indoor air quality monitor measures the CO₂ level in the range from 0 to 9999 ppm, the resolution is 1 ppm, and the accuracy is ± 50 ppm and $\pm 5\%$ of the reading. The devices were placed close to the centre of the occupied area at a height of about one meter. The air temperature in the room was also measured at the head and foot level of the room’s users.

Information was collected on the people staying in the classrooms, including the number of people, their gender and age. Efforts were also made to determine the relationship between the environmental factors and the symptoms of the Sick Building Syndrome (SBS). This phenomenon applies to buildings in which at least 20% of the people, while inside them, notice the appearance and intensification of symptoms such as: general malaise, irritability, permanent feeling of fatigue and sleepiness

as well as problems with concentration, headaches, irritation of the eyes, nose and throat, skin allergies or problems with the respiratory system [39]. They are also referred to as Building Related Illness (BRI). These ailments are closely related to the improper environmental conditions inside rooms and their insufficient ventilation [11]. They decrease or disappear after leaving the building. To assess the impact of staying in a given environment on the perception of SBS symptoms, questionnaires developed on the basis of literature and our own experiences related to the study of the impact of the environment on the thermal comfort and well-being of people staying in them were used.

CHARACTERISTICS OF THE BUILDINGS AND THE THERMAL RETROFIT ACTIVITIES

For the analysis, typical school buildings erected using traditional technologies between the years 1951-1976 with full or partial basements were selected. The buildings were heated from their own boiler room. Due to worn-out heating devices and the lack of insulation of pipes, the central heating systems were characterised by having low efficiency. Preparation of domestic hot water was undertaken locally in sanitary facilities from electric heaters or centrally from boiler rooms. The low thermal insulation of the building envelopes led to excessive heat losses and was not conducive to energy savings (Fig. 4). In some building envelopes, water vapour condensation occurred, which additionally resulted in a decrease in the building’s thermal insulation.

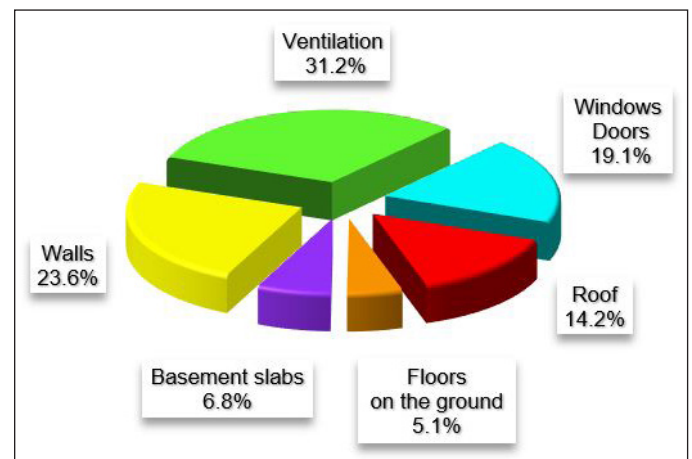

Fig. 4. Heat loss from buildings before the thermal retrofit

Table 1. Thermal insulation requirements of the external envelope per the year

Years	COEF	Wall	Basement slab	Roof	Floor on the ground	Window	Door
		W/(m ² K)					
2002-2008	$U_{k,max}$	0.45	0.60	0.30	0.67	2.6	2.6
2009-2013	U_{max}	0.30	0.45	0.25	0.80	1.8	2.6
2014-2016	$U_{c,max}$	0.25	0.25	0.20	0.30	1.3	1.7
2017-2020	$U_{c,max}$	0.23	0.25	0.18	0.30	1.1	1.5
From 2021	$U_{c,max}$	0.20	0.25	0.15	0.30	0.9	1.3

$U_{k,max}$ - maximum allowable value of the thermal transmittance
 $U_{c,max}$ - maximum allowable value of the corrected thermal transmittance
 $U_{k,max}$ - maximum allowable value of the thermal transmittance with thermal bridges

Between the years 2006-2019, the buildings underwent modernisation. The thermal retrofit work was aimed at increasing their energy efficiency, adapting to the applicable requirements in the field of thermal protection related to thermal insulation and energy savings, and reducing their negative impact on the environment. As part of the thermal retrofitting, the external partitions were insulated and windows and doors were replaced. The thickness of the insulation was selected in accordance with the requirements of the thermal insulation of external envelopes in force in Poland at the time when the thermal retrofit project of a given building was carried out. The requirements related to the level of thermal insulation of a building envelope in Poland in the specific years are presented in Table 1.

In the particular years, the requirements related to the different maximum values of the thermal transmittance coefficient are: U , U_c or U_k . The requirements for windows and doors have always been related to the U-value.

Various changes have also been made to the heating and hot water systems of the individual buildings. In the buildings, the coal or gas boilers were replaced with devices of higher efficiency, equipped with automatic regulation and system control elements. The installation was rebuilt, heating elements with a low thermal inertia and thermostatic valves were installed, insulation covers were installed on the central heating pipes, ineffective electric heaters were replaced with centralised heating from internal boiler rooms or replaced with new ones. Heating pauses have been introduced or increased, which were left in the buildings' gravitational ventilation system, and if necessary, diffusers mounted in the windows were used.

After the thermal insulation, the thermal and humidity parameters of the external envelope improved considerably and the thermal transmittance decreased on average by about 60-80%. The values of the coefficients for the individual external envelope before and after the thermal retrofit are presented in Table 2.

Table 2. Thermal transmittance before and after the thermal retrofit

Thermal transmittance $W/(m^2 K)$	Before thermal retrofit		After thermal retrofit	
	Harmonic mean	Standard deviation	Harmonic mean	Standard deviation
Walls	1.33	0.23	0.22	0.02
Roofs	0.95	0.22	0.17	0.03
Basement slabs	1.18	0.14	0.33	0.06
Floors on the ground	0.87	0.11	0.35	0.04
Windows	2.6	0	1.3	0.2
Doors	3.1	1.8	1.5	0.3

Over 100% improvement in the efficiency of the heating systems also contributed to the decrease in the heat consumption in the considered buildings. The following energy parameters of the buildings were determined: EU - the indicator of the annual demand for usable energy, EK - the indicator of the annual demand for final energy, EP - the indicator of the annual demand for primary energy, and Q/A_f - the indicator of the energy consumption in relation to the temperature-controlled surface. The energy parameters of the buildings before and after the thermal retrofit are presented in Table 3.

The estimated average value for the annual demand of the final energy decreased by 73%. A slightly higher energy consumption was observed

Table 3. Energy parameters of the buildings before and after the thermal retrofit

Indicator, kWh/(m ² year)	Before thermal retrofit		After thermal retrofit	
	Harmonic mean	Standard deviation	Harmonic mean	Standard deviation
EU	186.3	45.6	62.4	12.7
EK	278.4	55.7	75.8	12.9
EP	333.8	52.4	84.7	12.3
Q/A _f	281.7	48.6	76.1	15.1

after the thermal retrofitting in relation to the calculated demand for the final energy. Checks made of the installed thermal insulation did not reveal any errors thus far. A reason for the increased energy consumption may be due to the frequent airing of the rooms due to the poor air quality without closing the thermostatic valves, as they were often blocked. Despite the significant reduction in the energy consumption, an absolute reduction in the heating and domestic hot water costs has not been achieved, which is associated with a significant increase in the energy costs in the recent period.

The analysed thermal retrofitting projects are also characterised by a comprehensive approach to the problem of air protection, by indicating methods of reducing emissions, both as a result of modernisation activities within the building structure and related to the production, transmission and use of heat. Based on the results of an assessment of the air quality in the Silesian Voivodeship, the levels of air pollutant concentrations were close to the permissible levels, but also significantly exceeded them in some periods of the heating season, especially benzo(a)pyrene and particulate matter. The obtained results of the analysis indicate the possibility of achieving ecological effects expressed in the reduction of the total emission of gaseous and dust substances to the atmosphere at a level of approximately 68%.

THE INDOOR ENVIRONMENTAL CONDITIONS IN THE BUILDINGS BEFORE AND AFTER THE THERMAL RETROFITTING. RESULTS AND DISCUSSIONS

The proper shaping of the value of the individual elements related to the indoor microclimate in rooms is one of the basic conditions for achieving the thermal comfort, general well-being and health for people staying in a given environment. The thermal elements of the microclimate have the strongest direct impact on the assessment of the environment. Non-thermal elements, the complexity of which is extensive and includes many physical, chemical and biological factors, are also extremely important for the proper functioning of the body. The average values of the basic thermal elements of the indoor microclimate measured in the educa-

Table 4. Thermal parameters of the microclimate before and after the thermal retrofitting

Parameters	Before thermal retrofitting		After thermal retrofitting	
	Arithmetic mean	Standard deviation	Arithmetic mean	Standard deviation
ϑ_p , °C	19.4	2.4	22.7	2.8
ϑ_n , °C	20.7	2.8	23.8	1.5
φ_p , %	43.6	19.3	29.4	16.3
Parameters	Harmonic mean	Standard deviation	Harmonic mean	Standard deviation
v_p , m/s	0.24	0.11	0.12	0.07

tional rooms: air temperature (ϑ), ambient radiation temperature relative (ϑ_r), air humidity (φ) and air flow velocity (v) along with the value of their standard deviation before and after the thermomodernisation are presented in Table 4.

The air temperature in the rooms before the thermal retrofitting was, on average, 19.4 °C with a standard deviation of 2.4 °C, however, near leaky windows, a significantly lower temperature value and an increased air flow velocity were recorded. In addition to the symmetrical thermal load on the body, the evenness of the air temperature distribution in the rooms has a significant impact on the positive assessment of the environmental conditions. The temperature gradient in the vertical direction usually depends on the type of heating and the location, size and temperature of the radiators. In most classrooms, heaters were placed on the outer wall under the windows, just above the floor. The temperature difference between the level of the head and the feet was around 2.6 °C. Typical school buildings are characterised by a significant amount of glazing of the facade, especially in classrooms. The maximum value of the glazing in the facade of the room in the assessed buildings was nearly 70%. The size of the glazing and its leakage affect the air temperature and thermal stability in the interior. In winter, large windows usually cause lower temperatures in the room, especially the perceived temperature. The low thermal insulation of the windows was undoubtedly the cause of a much lower temperature on the inner surface compared to the temperatures on the surface of the external envelope. As a person radiates more heat towards cold windows, this could have been the reason for the uneven cooling of the body, and thus causes issues in the process of thermoregulation and discomfort. With low thermal insulation, the low temperature of the surrounding opaque external envelope also causes an increase in the asymmetry of the thermal radiation field and a decrease in the ambient radiation temperature, but to a lesser extent than in the case of the windows. The window leakage could additionally intensify the radiation asymmetry effect, causing a feeling of discomfort not only near the windows, but also away from them, especially in windy weather. The differences in temperature and air flow velocity were found. Near the leaky windows, the recorded air temperatures were 2.5 to 5 °C lower than in the centre of the rooms, and the air flow rate increased about 2 to 4 times. The excessive glazing had a negative impact on the microclimate conditions in the rooms, also during the days with strong solar radiation, which resulted in increased overheating of the rooms with the lack of local temperature control. The adverse effects of excessive sunlight could be mitigated by the use of various types of curtains, but this necessitated the use of artificial lighting and increased the energy consumption. After the thermal retrofitting in the rooms, an increase in the air temperature was noted and no significant drop near the windows was noted. The air temperature gradient in the room did not exceed 0.5 °C/m. The temperature by the floor did not differ by more than about 1.4 °C from the average air temperature determined for a given room.

Before the thermal retrofitting, a slightly higher level of relative air humidity was found. The value of the air humidity oscillated most often from 30 to 55% at the end of the school tasks. During the day, there was a gradual increase in the value of the humidity by about 20-25%. After the thermal retrofit, the value of the air humidity in the rooms decreased. The low thermal insulation of the external envelope combined with a significant level of air humidity in some rooms in the given time period were probably related to the development of microorganisms on the internal surfaces of the building envelope in these rooms. Traces of mould were observed on the surface of the walls within the window recess. After the thermal retrofit, this phenomenon was completely eliminated. In perfectly clean air, the combined low relative humidity and higher temperature are not that bothersome. In polluted air, at a low relative humidity, dust particles and other air pollutants float up and settle on the radiators.

Then, gases are produced that irritate the respiratory tract. In dry air, plastics pick up static more easily, which additionally attracts dust particles. This is the main cause of discomfort in the heating season and irritation of the respiratory system.

Before the thermal retrofit, the air flow velocity in the rooms was slightly higher and increased significantly near the leaky windows. Air movement is of course necessary for proper ventilation and heat transfer, but the increased flow of cool air and the formation of draughts caused discomfort. Mainly air with a temperature lower than the air temperature in the room has a negative effect on people, disturbing their thermal sensations. Air flow with a temperature much lower than the air temperature in the room is particularly acute in the floor zone, especially in nursery school buildings. The floors in these types of buildings are a place where children like to play during the day. After the thermal retrofit, the air speed remained at a relatively low level of about 0.12 m/s and did not exceed 0.2 m/s.

A serious problem in the classroom environment is the recorded high carbon dioxide concentration level. Carbon dioxide contained in the air in a concentration of up to about 500 ppm is not harmful to humans, but higher concentrations, especially for people with low tolerance to CO₂, may already cause dyspnoea associated with the difficult excretion of carbon dioxide generated in the human body. An acceptable limit is an air concentration of up to 1000 ppm. A concentration above 1000 ppm results in impairment of intellectual abilities, and a concentration above 2500 ppm also significantly reduces physical abilities. The conducted research shows, unfortunately, that students of schools subjected to thermal retrofitting are more often exposed to increased concentrations of carbon dioxide during lessons than students in buildings not subjected to thermal retrofitting [17].

The main source of carbon dioxide contamination of the rooms was the users' breathing. During the day, the rooms in the educational buildings were used during school tasks, and during the breaks, the students left the classrooms and the rooms were intensively ventilated by opening the windows. The concentration of the carbon dioxide in classrooms changed dynamically depending on the number of people, the size of the rooms and the frequency of airing them. The carbon dioxide concentration was measured in only two buildings. An alarming phenomenon was observed. Although the level of CO₂ did not exceed 1400 ppm before the thermal retrofit, a concentration of 2307 ppm was recorded after the thermal retrofit. Fig. 5 shows the changes in the carbon dioxide concentration in the air in the classroom during the working day in the educational building where the thermal retrofitting was carried out.

In the assessment of the quality of the environment before and after the thermal retrofit, the laboratory room located on the ground floor of the university building with windows on the eastern facade was included. The values of the selected parameters were recorded here continuously.

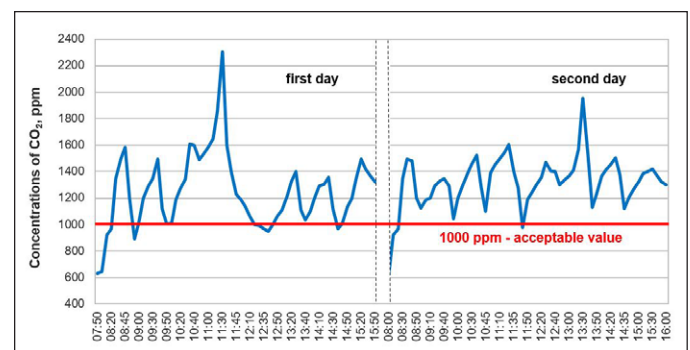

Fig. 5. The changes in the carbon dioxide concentration in an educational room after the thermal retrofit

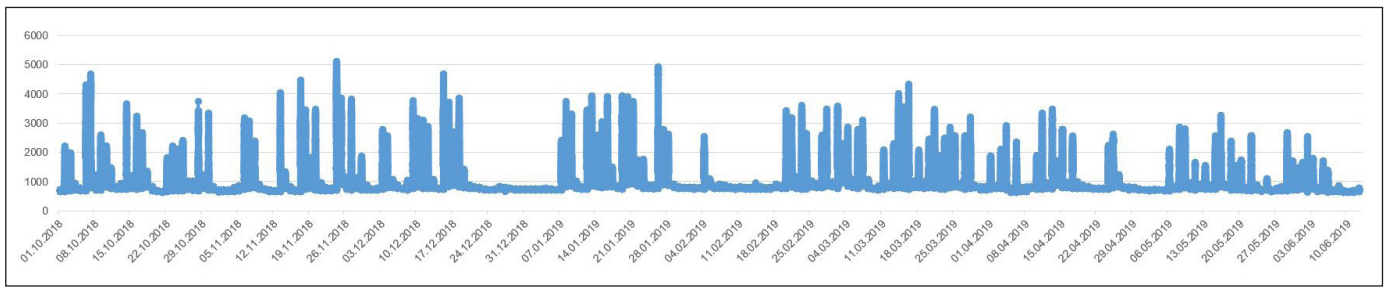

Fig. 6. Changes in the carbon dioxide concentration (in ppm) in the laboratory room before the thermal retrofit

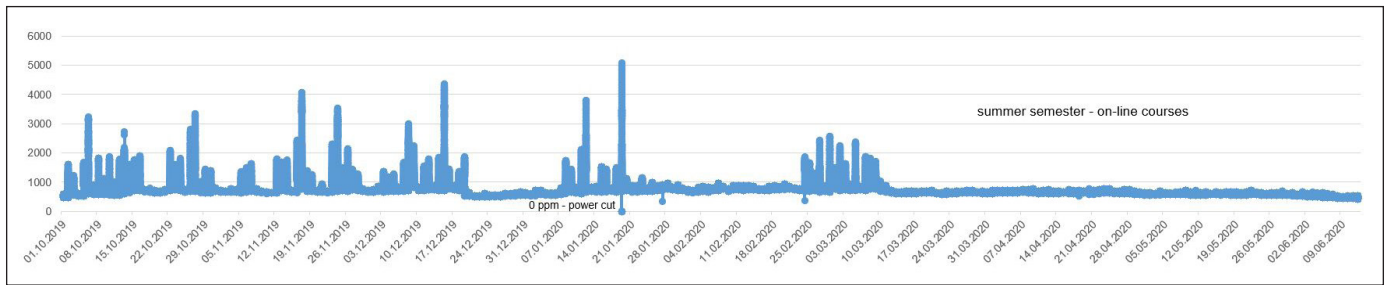

Fig. 7. Changes in the carbon dioxide concentration (in ppm) in the laboratory room after the thermal retrofit

The thermomodernisation of this building, carried out in 2019 and completed at the beginning of 2020, did not include replacement windows, as they had already been replaced with new plastic ones much earlier. Despite the diffusers installed in the windows, a particularly high concentration of carbon dioxide was recorded in the room (Fig. 6). Students and teachers often complained of sleepiness and problems with concentration during coursework. Initially, after the thermal insulation installation, high levels of carbon dioxide concentrations were still recorded in the room (Fig. 7). Unfortunately, observations regarding the carbon dioxide concentration after the thermal retrofiting was interrupted due to the COVID 19 pandemic. The courses in the summer semester were conducted on-line. Due to the fact that the windows in the building had been replaced earlier, the level of ventilation in the room before and after the thermal retrofit did not differ much.

The obtained results confirmed that the traditional ventilation systems used in the educational buildings in the form of gravity ventilation are not able to provide adequate microclimate conditions in the rooms during classes. The inefficient ventilation systems contributed to the maintenance of very high levels of carbon dioxide most of the time.

After the thermal retrofit in the laboratory room, there was a clear increase in the air temperature and a decrease in the air relative humidity. Before the thermal retrofit, the air temperature ranged between 18-22 °C, after the thermal retrofit, it was in the range of 23-26 °C. Before the thermal retrofit, the relative air humidity fluctuated in the range of 30-60%, after the thermal retrofit, it was within the range of 20-40%.

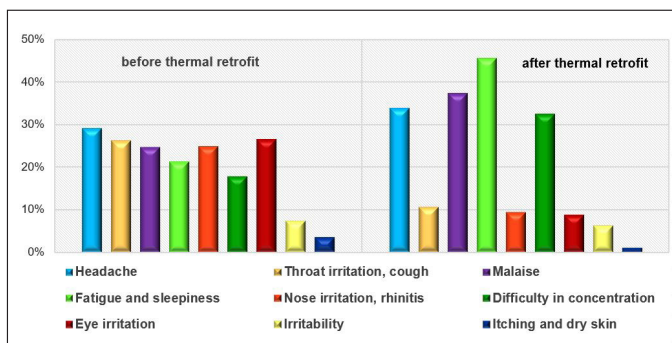

Fig. 8. The sick building syndrome symptoms before and after the thermal retrofit

During studies in educational buildings, symptoms of the sick building syndrome were observed in people staying in the rooms, which they identified with a long-term stay in a given environment. The occurrence of symptoms in the studied population of people before and after the thermal retrofit is shown in Figure 8.

Some of the symptoms of the sick building syndrome, primarily the eye, nose and throat irritation or skin allergies, were partially resolved after the thermal retrofiting. An increase in the fatigue, sleepiness, and difficulty in concentrating may be related to the increase in the carbon dioxide levels in the rooms. Overall, poor indoor air quality was reported by around 90% of the room occupants. The feeling of a lack of fresh air resulted in the need for additional ventilation of the rooms by opening windows. In the heating season, it was the cause of an increase in the heat loss and the temporary deterioration of the thermal comfort conditions among people staying in the rooms while airing them, due to the reduction of the temperature in the room and an increase in the speed of the cold air flow.

CONCLUSION

Thermal protection of buildings is directly related to, but not limited to, energy savings. The purpose of thermal protection should also be to ensure appropriate indoor environmental conditions. The environment in which a person resides should allow them to achieve a state of satisfaction with the prevailing conditions and fully satisfy their physical and mental needs. With a comprehensive approach to thermal retrofitting in accordance with the assumptions contained in the audit analysis, one should expect not only a reduction in the energy consumption for a building's heating and preparation of domestic hot water as well as a reduction in the emissions of harmful substances into the atmosphere from fuel combustion, especially the reduction of particularly troublesome low emissions when powered from internal boiler rooms, but also improvement in the indoor microclimate and thermal comfort or well-being of its users. However, attention must be drawn to the deterioration of the indoor air quality due to the tightening of the thermal protection requirements for buildings in the implementation of energy efficiency programmes. The research carried out in the selected educational buildings showed the benefits of thermal retrofit works in these types of buildings,

but also allowed for the observation of certain irregularities related to the implementation of the established solutions under certain restrictions.

1. Increasing the thermal insulation of partitions and modernisation of the heating system and hot water preparation significantly improved the energy efficiency of educational buildings.
2. A partial improvement in the microclimate conditions in the rooms and a feeling of thermal comfort by the classroom users were found after the thermal retrofit works.
3. There was an increase in the indoor temperature, which was positively received by the respondents, especially when the air temperature in the classrooms remained lower than the determined average.
4. A temperature control lock in the rooms protects against the improper use of thermostatic valves by children, however, enabling local temperature control by appropriate persons, e.g., teachers, would simultaneously reduce the energy consumption for heating the buildings by taking solar gains into account in the overall balance and limit the burdensome overheating of rooms in the heating season in the case of strong solar radiation.
5. The relative air humidity decreased, even in a few cases, to a value unacceptable by the respondents.
6. The development of mould in the area of windows and the phenomenon of water vapour condensation inside the building envelope occurring before the thermal retrofit has been completely eliminated after the retrofit.
7. Conducting a building's thermal retrofit contributed to the partial elimination of some health problems related to the sick building syndrome, such as irritation of the eyes, nose, throat or skin.
8. After the thermal retrofitting, however, an intensification of some of the syndrome symptoms, in which the users of the rooms associated with the deterioration of indoor air quality, was found to intensify, in particular, there were complaints about sleepiness and difficulties with concentration.
9. There was an increase in the concentration of carbon dioxide after a room's longer period of use, most likely related to the limitation of the ventilation process with the significant sealing of the building envelope in the case of leaving the gravity ventilation system after the thermal retrofit.
10. Failure to meet hygienic requirements and the lack of fresh air has a significant impact on the well-being and health of children, the concentration of carbon dioxide at the level of 2000-3000 ppm does not ensure the safety of staying indoors.
11. The importance of the proper shaping of the internal environment of educational buildings also applies to the impact of these environments on the educational process, as a concentration above 1000 ppm results in impairment in the ability to perform mental work.
12. Increasing the flow of ventilated air increases the operating costs of the buildings related to their heating, but generates clear benefits for the health and quality of education.
13. Increasing the amount of ventilated air exchange in the environment of educational buildings improves the children's efficiency in carrying out school tasks, their concentration and well-being, reduces the health effects related to the impact of the environment and reduces the absenteeism of school students.
14. The proper ventilation of rooms allows not only the elimination of many health problems associated with the sick building syndrome, but also eliminates utility problems, such as mould in the partitions.
15. The feeling of lack of fresh air made it necessary to ventilate the rooms by opening windows, which, in the heating season, was the cause of intensifying heat losses and the temporary deterioration of thermal comfort conditions due to the increased flow velocity of the cold air stream.
16. Since the primary function of ventilation is to provide room users with physiological comfort, i.e., an environment in which the concentration of gaseous pollutants and metabolic products is maintained at an acceptable level, it would be beneficial to introduce a constant, gradual supply of fresh air to the rooms, necessarily taking the measures aimed at reducing outdoor air pollution entering the interior into account.
17. The gravity ventilation system, also commonly used after thermal retrofits in educational buildings, is not able to ensure the air exchange in the amount necessary to ensure appropriate hygienic and health conditions.
18. In educational buildings, it would be best to use an automatically controlled ventilation or heating and ventilation system of a regulated air supply, with simultaneous heat recovery from the used air, purification of the air supplied to the rooms and warming it in winter.
19. The use of mechanical ventilation would eliminate the need for frequent ventilation by opening the windows, it would allow for the more complete control over the amount and quality of air reaching the rooms and contribute to reducing heat loss and, thus, the energy consumption, by simultaneously improving the microclimate of the interior and the thermal comfort conditions of people staying in them and the SBS symptoms.
20. One should always strive to create such optimal indoor conditions that each person feels satisfied with the environment in which they usually stay and that it does not adversely affect their well-being and health.
21. Ensuring adequate indoor air quality seems to be a key problem, especially in educational buildings, considering the long-term exposure to the environment, comparable to the working time of adults, to not yet fully formed and particularly sensitive children's organisms, especially in preschool and early school ages.

Contact: alis@bud.pcz.pl

References

- [1] Commission recommendation (EU) 2019/786 of 8 May 2019 on building renovation. *Official Journal of the European Union*. 2019, L127/34.
- [2] DELGADO, J.M.P.Q. Indoor Environmental Quality of School Buildings. *Defect and Diffusion Forum*. 2016, V. 369, pp.24-29. ISSN 1662-9507.
- [3] Directive 2010/31/EU of The European Parliament and of the Council of 19 May 2010 on the energy performance of buildings (recast).
- [4] Directive 2018/844/EU of The European Parliament and of the Council of 30 May 2018 amending Directive 2010/31/EU on the energy performance of buildings and Directive 2012/27/EU on energy efficiency.
- [5] ERHORN-KLUTTIG, H., ERHORN, H., et al. EU project "School of the future" – refurbishment of school buildings toward zero emission with high-performance indoor environment. *ASHRAE Transactions*. 2016, V. 122, No 1, pp. 315-325. ISSN 0001-2505.
- [6] ERLANDSON, G., MAGZAMEN, S., et al. Characterization of Indoor Air Quality on a College Campus: A Pilot Study. *International Journal of Environmental Research and Public Health*. 2019, V. 16, No. 15, 2721. ISSN 1660-4601.
- [7] FINELL, E., TOLVANEN, A., et al. Indoor air problems and the perceived social climate in schools: a multilevel structural equation analysis. *Science of the Total Environment*. 2018, V. 624, pp. 1504–1512. ISSN 0048-9697.
- [8] HAVERINEN-SHAUGHNESSY, U., SHAUGHNESSY, R.J., et al. An assessment of indoor environmental quality in schools and its association with health and performance. *Building and Environment*. 2015, V. 9, No. 1, pp. 35-40. ISSN 0360-1323.
- [9] HU, M. Assessment of effective energy retrofit strategies and related impact on indoor environmental quality: A case study of an elementary school in the State of Maryland. *Journal of Green Building*. 2017, V. 12, No. 2, pp. 38–55. ISSN 1552-6100.
- [10] JAYASOORIYA, V.M., RAJAPAKSHA, R.M.D.H., et al. Associations of Indoor Carbon Dioxide Concentration and Symptoms of Sick Building Syndrome in Air-Conditioned Lecture Halls. Research Square, 2020. Available with: <https://www.researchsquare.com/article/rs-95698/v1>.

- [11] KAPALO, P., KLYMENKO, H., et al. Evaluating the state of sanitary and hygienic conditions in ventilated rooms. *Bulletin of the Lviv Polytechnic National University. Collection of scientific papers. Series: Theory and Building Practice*. 2019, V. 55, No. 912, pp. 63-67. ISSN 0321-0499.
- [12] KAPALO, P., VOZNYAK, O., et al. Ensuring comfort microclimate in the classrooms under condition of the required air exchange. *Eastern European Journal of Enterprise Technologies*. 2018, V. 5, No. 10, pp. 6-14. ISSN 1729-3774.
- [13] KAPALO, P., VOZNYAK, O., et al. Perception of air quality in the selected classroom. *BoZPE*. 2019, V. 8, No. 2, 77-84. ISSN 2299-8535.
- [14] LE, A.T.H., PARK, K.S., et al. Sustainable refurbishment for school buildings: a literature review. *International Journal of Building Pathology and Adaptation*. 2021, V. 39, No. 1, pp.5-19. ISSN 2398-4708.
- [15] *Long-term renovation strategy to support the renovation of the national stock of both public and private residential and non-residential buildings*. Prague: Ministry of Industry and Trade of the Czech Republic, 2020.
- [16] *Long-term Renovation Strategy. Supporting the Renovation of the National Construction Resource*. Warsaw: Ministry of Economic Development, Labour and Technology of the Republic of Poland, 2021.
- [17] MAINKA, A., ZAJUSZ-ZUBEK E. Determination on carbon dioxide levels in school buildings: the effect of thermal efficiency improvement. *Engineering and Protection of Environment*. 2018, V. 21, No. 2, pp. 155-162. ISSN 1505-3695.
- [18] MICHALIK, M., MIZERA, G., et al. Problems with microclimate in classrooms – results of measurements and proposed solution. *Eco-Energetics: technologies, environment, law and economy*. 2021, V. 3-4, pp. 11-20. ISSN 2657-5922.
- [19] MICHALAK, P., SZCZOTKA, K., SZYMICZEK, J. Energy effectiveness or economic profitability? A case study of thermal modernization of a school building. *Energies*. 2021, V. 14, 1973. ISSN 1996-1073.
- [20] MIHAL, T., IORDACHE, V. Determining the indoor environment quality for an educational building. *Energy Procedia*. 2016, V. 85, pp. 566-574. ISSN 1876-6102.
- [21] MIJAKOWSKI, M., RUCIŃSKA, J., et al. The concept of improving indoor environment in an exemplary public utility building modernized to the nZEB standard. *Building Physics in Theory and Practice*. 2017, V. 9, No. 4, pp. 15-20. ISSN 1734-4891.
- [22] *Mikroklima ve školních budovách. Energetická náročnost, komfort, legislativa*. Available with: <https://www.eazk.cz/wcd/projekty-eu/climactregions/mikroklima-skoly.pdf>
- [23] MISHRA, A.K., SCHIAVON, S., et al. Carbon dioxide and its effect on occupant cognitive performance: A literature review. In: *Windsor 2020. Resilient Comfort. Proceedings*. 2020, pp. 432-444. ISBN 978-1-9161876-3-4.
- [24] MOHELŇKOVÁ, J., NOVOTNÝ, M., MOCOŤVÁ, P. Evaluation of school building energy performance and classroom indoor environment. *Energies*. 2020, V. 13, No. 10, 2489. ISSN 1996-1073.
- [25] ÖSTERREICHER, D. A Methodology for Integrated Refurbishment Actions in School Buildings. *Buildings*. 2018, V. 8, No. 3, 42. ISSN 2075-5309.
- [26] ÖSTERREICHER, D., GEISLER, S. Refurbishment in educational buildings – methodological approach for high performance integrated school refurbishment actions. *Energy Procedia*. 2016, V. 96, pp. 375-385. ISSN 1876-6102.
- [27] PETERSEN, S., JENSEN, K.L., et al. The effect of increased classroom ventilation rate indicated by reduced CO₂ concentration on the performance of schoolwork by children. *Indoor Air*. 2016, V. 26, No. 3, pp. 366-79. ISSN 1600-0668.
- [28] RUCIŃSKA, J. Improving the Energy Quality and Indoor Environmental Quality in Retrofit Buildings. In: RYŃSKA, E., KOZMINSKA, U., et al. *Design Solutions for nZEB Retrofit Buildings*. Hershey: IGI Global, 2018, pp. 186-208. ISBN 978-1-52254-105-9.
- [29] SARKHOSH, M., NAJAFPOOR, A.A., et al. Indoor Air Quality associations with sick building syndrome: An application of decision tree technology. *Building and Environment*. 2021, V. 188, 107446. ISSN 0360-1323.
- [30] *School of the future. Towards zero emission with high performance indoor environment. Final Demonstration Building Report*. M. ZINZI ed. Germany: Fraunhofer-IBP, 2016. ENER/FP7/260102.
- [31] *Sick building syndrome - causes, how to prevent*. Available with: <https://www.instalacjebudowlane.pl/10423-33-68-syndrom-chorego-budynku-przyczyny-jak-zapobiegac.html>.
- [32] SOWA, J. Jakość powietrza w budynkach modernizowanych. *Izolacje*. 2018, V. 23, No. 2, pp. 76-82. ISSN 1427-6682.
- [33] SOWA, J., NOGA-ZYGMUNT, J., UGOROWSKA, J. Indoor air parameters in higher education building before planned modernization to nZEB standard. *Building Physics in Theory and Practice*. 2017, V. 9, No. 3, pp. 41-46. ISSN 1734-4891.
- [34] VILCEKOVA, S., KAPALO, P., et al. Investigation of indoor environment quality in classroom - Case Study. *Procedia Engineering*. 2017, V. 190, pp. 496–503. ISSN 1877-7058.
- [35] VORNANEN-WINQVIST, C., TOOMLA, S., et al. The effect of positive pressure on indoor air quality in a deeply renovated school building – a case study. *Energy Procedia*. 2017, V. 132, pp. 165-170. ISSN 1876-6102.
- [36] WARGOCKI, P. What are indoor air quality priorities for energy-efficient buildings? *Indoor and Built Environment*. 2015, V. 24, No. 5, pp. 579-582. ISSN 1420-326X.
- [37] WARGOCKI, P. Productivity and health effects of high indoor air quality. In: NRIAGU, J.O., ed. *Encyclopedia of Environmental Health*. Elsevier, 2019, pp. 382-388. ISBN 978-0-444-63952-3.
- [38] WARGOCKI, P., WYON, D.P. Ten questions concerning thermal and indoor air quality effects on the performance of office work and schoolwork. *Building and Environment*. 2016, V. 112, pp. 359–366. ISSN: 0360-1323.
- [39] *WHO guidelines for indoor air quality*. Copenhagen: World Health Organization, 2010. ISBN 978-92-890-0213-4.
- [40] WIERZBICKA, A., PEDERSEN, E. Healthy indoor environments: The need for a holistic approach. *International Journal of Environmental Research and Public Health*. 2018, V. 15, No. 9, 1874. ISSN 1660-4601.
- [41] ZUHAIB, S., MANTON, R., et al. An Indoor Environmental Quality (IEQ) assessment of a partially-retrofitted university building. *Building and Environment*. 2018, V. 139, pp. 69-85. ISSN 0360-1323.
- [42] ŻYCZYŃSKA, A., SUCHORAB, Z., et al. Energy Effects of Retrofitting the Educational Facilities Located in South-Eastern Poland. *Energies*. 2020, V. 13, 2449. ISSN 1996-1073.

Practical Experience with Self-drying Insulation for Cold Piping

Praktické zkušenosti s kapilárně aktivní izolací pro rozvody chladu

Self-drying insulation for cold piping is based on the capillary suction of a fibre fabric to remove condensed water vapour from cold pipe surfaces to the outer surface of the insulation, from where it will evaporate to the ambient air, as long as the ambient conditions allow for evaporation. The wick keeps the insulation dry, allowing it to maintain its thermal performance. The long-term accumulation of moisture in the insulation material is avoided. This paper describes the principle of the wick-concept insulation and also the results of an experiment. The results show that this type of open cell insulation works for pipes with temperature above 0 °C.

Keywords: self-drying insulation, wick-concept, moisture accumulation, cold piping, refrigeration, air conditioning

Článek se zabývá inovativním přístupem k izolacím rozvodů chladu, díky kterému se zamezí akumulaci vlhkosti v izolaci. To je možné použitím tepelné izolace s kapilárně vodivou tkaninou. Princip funkce je založen na kapilárním vedení vláknité skelné tkaniny, která slouží k odvedení zkondenzované vodní páry z povrchu chladného potrubí na vnější povrch izolace. Odtud se zkondenzovaná vodní pára odpařuje do okolního vzduchu. Izolační systém je takto schopen udržet své tepelněizolační vlastnosti po celou dobu životnosti izolace. Experimentální testování prokázalo, že tento typ izolace funguje u potrubí s povrchovou teplotou vyšší než 0 °C a pro okolní podmínky, které se běžně v praxi vyskytují.

Klíčová slova: tepelná izolace, rozvody chladu, kapilárně vodivá tkanina, akumulace vlhkosti, chlazení, klimatizace

INTRODUCTION

Cold pipe insulations are associated with solving water vapour condensation problems. The surface temperature of a cold pipe may be below the dew point of the ambient air. In these periods, the water vapour will move from the ambient air towards the surfaces of the cold pipes, where it will condensate and will drip away. Therefore, cold pipe surfaces must be insulated. The thickness of the insulation must be sufficient enough to increase the insulation outer surface temperature above the dew point. However, the water vapour will still be driven towards the cold pipe which will result in moisture accumulation in the insulation. The accumulation rate depends on the insulation material's properties.

The water vapour accumulation in the insulation can be minimised by three principles described in EN ISO 15758:

- Installation of a vapour retarder;
- Use of insulation material with a high water vapour resistance factor (low permeability);
- Use of a vapour retarder and a capillary active fabric to continuously remove condensed water from the pipe surface to the environment. This method is based on the wick-concept and such an insulation system can be called self-drying.

THE WICK-CONCEPT

The idea behind the wick-concept arose from the fact that it is not quite possible to make a 100 % perfectly water-tight insulation job. In practice, the insulation does not prevent water vapour migration and ultimately, condensation forms on cold pipe surfaces. Even if it were possible, flaws in the water tightness would invariably appear over time. Hence, we propose the removal of the condensate water from cold pipe surfaces, which is possible by the wicking action of certain fabrics (e.g., glass fibre fabric) that can move the moisture from a place with a high-

er moisture content to one with a lower moisture content. This wicking action works as long as the temperature at the low moisture surface is above the freezing point.

Principle of operation

The tubular insulation shown in Figure 1 has an internal fabric lining with

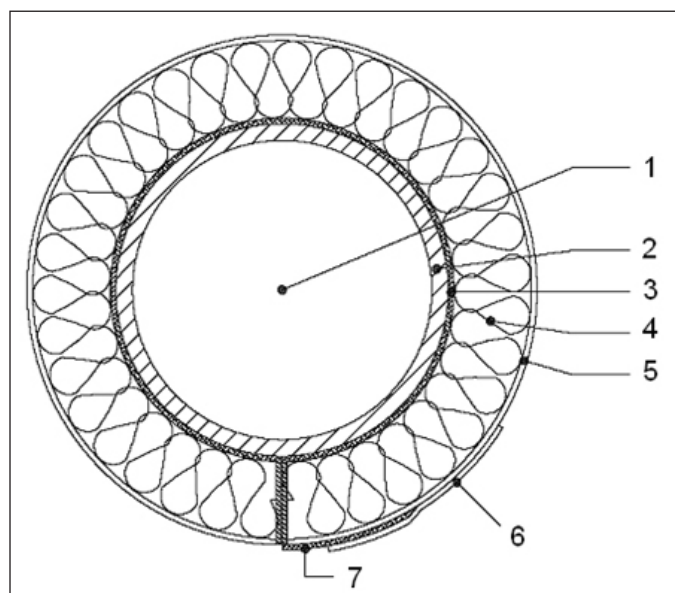

Figure 1. The self-drying insulation [2]

- 1 Fluid temperature below the dew point of the ambient air
- 2 Cold pipe
- 3 Wick fabric
- 4 Glass wool pipe section
- 5 Vapour retarder jacket (aluminium foil)
- 6 Aluminium overlap for attachment of the wick fabric
- 7 Evaporation area



Figure 2. The self-drying insulation in the HVAC laboratory in Brno

good capillary suction properties. The fabric extends into the slot and protrudes to the outer insulation surface. For horizontal pipes, their longitudinal slot should, preferably, be placed downward as to help remove the condensate through gravitation.

It is the capillary suction of the fabric wick that moves the moisture from the pipe's surfaces to the part protruding outside. There, the protruding part, the wick, evaporates the moisture to the ambient air, as long as the dew point of the ambient air is below the surface temperature of the jacket, which is also the temperature of the wick. If the dew point is equal to or higher than the temperature, condensation will appear on the jacket and wick and it then may start to drip. This, however, does not mean that the condensate accumulates in the insulation. Instead, it continues to drain through the wick fabric by gravitation and the insulation will stay dry.

The slot in the vapour retarder jacket, through which the fabric wick protrudes, can be considered a flaw in the jacket, but the water vapour cannot diffuse through the slot. The explanation is as follows: In the start-up period when the wick is dry, the vapour will be driven from the air in the room to the cold pipe. For example, if the room condition is 22 °C and 60 % relative humidity (RH), the vapour pressure is 1580 Pa. If the temperature of the pipe's surface is 6 °C, the saturation pressure is 930 Pa. The vapour will be driven at 650 Pa towards the pipe. After some time (in days), the fabric wick will become moist and the vapour pressure in the gap will increase to almost saturation at room temperature, which is 2630 Pa. This means that there will be a drying potential from the protruding wick towards the air in the room and, therefore, the water vapour from the air in the room cannot diffuse into the slot in the jacket. The water vapour can only diffuse into the insulation through the vapour retarder jacket and through any flaws.

When the boundary conditions are too severe (in terms of a high temperature and a high RH) the longitudinal joint should be sealed with perforated aluminium tape. This will slow down the diffusion of water vapour towards the cold pipe. Without the tape, more moisture could get into the

system, as the longitudinal slot would be too open for these conditions. The water vapour could bypass the wick and diffuse within the porous insulation.

EXPERIMENTS

The subsequent experiments were carried out in the laboratory of the Technical University of Denmark in Copenhagen. Four horizontal environmental chambers, a vertical chamber and two cooling plants were used. In each horizontal chamber, there were two cold pipes. Each pipe is capped on one end and has another pipe inside to provide flow. This test configuration will be called "cold fingers", its purpose is to allow for the periodic removal and weighing of the pipe insulation sections in order to determine the weight change due to the water vapour ingress.

The testing was conducted in environmental chambers with a controlled temperature and relative humidity. To keep constant humidity, NaCl saturation salt solutions were used which have an equilibrium relative humidity of 75 %. Figure 3 shows a photograph of one of the horizontal environmental chambers.

In the paper, only one example of the performed experiments is discussed. The description of all the experiments is described in [2].

Example of the experiment and results

In the experiment, two insulation pipe sections were installed on a cold finger. For the experiment, two 1" black pipes were used, which were covered with insulation pipe sections, 0.6 m in length with an outer diameter of 92 mm. The thickness of the insulation was 30 mm. The ends of the insulation pipe sections were covered by a PVC annulus and were sealed by caulking around them. These samples were initially weighed and then placed on the cold finger. The temperature of the cold finger



Figure 3. Samples in the horizontal environmental chamber

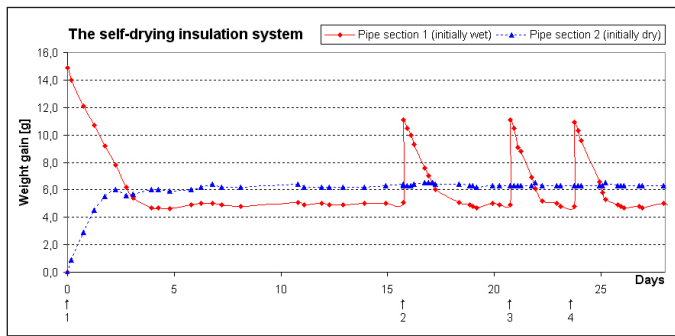

Figure 4. Weight gain in time

Table 1. Average boundary conditions during the experiment

Type of boundary condition	Average value
Temperature in the environmental box	20.2 °C
Relative humidity in the environmental box	70.5 %
Pipe temperature	6 °C

was maintained at the desired temperature, typically 5 °C. The test period was two months.

In order to have a wicking action in one of the samples from the beginning, the sample was installed with a fabric which was wetted with 15 ml of distilled water. This amount of water fully saturated the fabric wick. The other sample was installed dry.

As illustrated in Figure 4, the initial dry pipe (section 2) had a rapid weight gain within the first two days of testing. Afterwards, the weight of the sample remained constant. This is consistent with the assumption that an initial period of water accumulation must occur prior to saturating the wick. During this initial transient period, there is no liquid water at the slot, and the water vapour can diffuse into the system. The longitudinal “flaw” (joint) in the retarder jacket is narrow (around 1 mm), but runs along the length of the pipe.

In comparison, the other pipe (section 1), which had a wet fabric wick installed, began to remove the condensed water through the slot to the evaporation area immediately. After three days, the flow of water vapour diffusion into the system equalled the flow rate of the liquid water out of the system and a state of equilibrium was reached.

The data show that the weight gain during the initial transient period is roughly 5 to 6 grams per pipe section. If the wick fabric had been fully saturated, the weight gain should be 15 grams per pipe section. From this, a conclusion can be drawn that 1) the weight gain measured is confined to the wick material (it means that the insulation is dry) and 2) the wick material is less than 50 % saturated.

After 16 days (time mark 2), the fabric wick was wetted by adding 6 ml of water, and within three days, the moisture content of the fabric wick was at the same level as before it was made wet. At time mark 3 (day 21) and 4 (day 24), the fabric wick was wetted again with 6 ml of water, but now the pipe section was turned in the slot-up configuration. As can be seen, the wick also works without any gravitational help.

INSTALLATION INSTRUCTIONS

Installing the self-drying insulation is similar to that with the regular mineral wool insulation. It works by transporting moisture from the area

around the pipe to the surface of the insulation. This is accomplished through the wick material, but is aided by gravity. Therefore, the horizontal runs must have a series of evaporating holes located in the down position (this is 180° different than the current mineral wool pipe covering installation practice). Care must be taken during the installation to ensure that the wick material stays in place while sliding, twisting, turning and/or aligning the insulation sections. The pipe sections should be tightly butted together and secured to each other similar to traditional mineral wool pipe sections using aluminium tape. All the self-drying insulation system terminations should be sealed with aluminium tape. The terminations include the ends of the run transition to another material, ends at flanges, valves, etc.

The fabric wick must make a continuous connection (path) through all the pipes, flanges, fittings, valves and hangers. The flanges, fittings, valves and hangers must have the field-applied fabric wick wrapped in place to ensure the wick’s continuity (see Figures 5 and 6). Standard site-fabricated connections, such as mitred, segmented or fish-mouthed ones are recommended for the elbows and fittings. This practice will maximise the evaporation area. The insulation thickness must be the same as that of the adjacent piping.

The self-drying insulation can be applied for both new and replacement jobs. Unlike traditional cold insulations, this system may readily be installed on operating systems even if the pipes are wet. The recommended thickness to prevent surface condensation must be ensured.

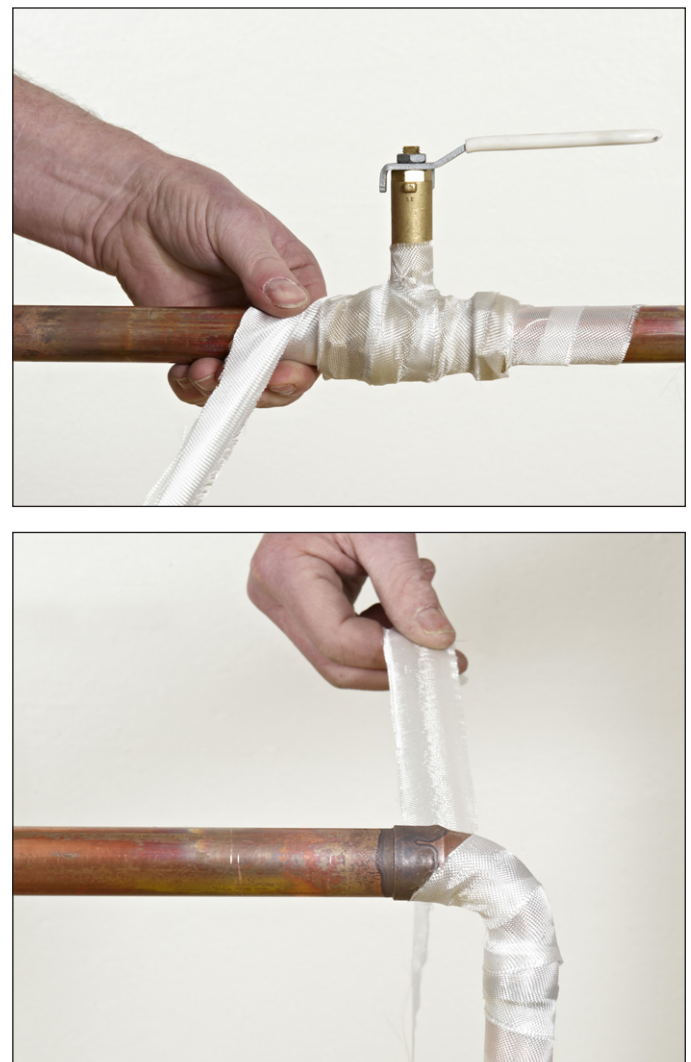

Figure 5. Insulating the valves and elbows – the field-applied fabric wick has to be wrapped around a pipe to ensure a continuous wick path along the pipe’s length



Figure 6. The pipe section with the manufacturing-applied fabric wick can be then placed into its position

The self-drying system is designed for insulation on cold or dual temperature piping operating at temperatures from 0 to 250 °C in buildings or industrial facilities. The concept can also be used for outdoor or exposed piping, but a second jacketing is then needed. The evaporation area (or the evaporation holes in the jacketing) must remain uncovered and unpainted at all times after installation. Painting over or covering the



Figure 7. The longitudinal joints should be sealed with perforated aluminium tape to ensure that the joint is closed



Figure 8. Frost deposit in the insulation when freezing temperatures occur; in this case, the piping was below zero

evaporation area will defeat the function of the system. Freezing temperatures of the outside air can occur only for a short period of time (days), which means that the system is not suitable for outside applications in countries where there are cold winters. Any moisture in the fabric wick could freeze which would stop the wicking action and would be followed by ice growing in the insulation.

Advantages for use in practice

The main advantage of the self-drying insulation is the fact that it is made of glass wool, which is non-flammable (Euroclass A₂-s1, d0 fire rating when classified in accordance with EN 13501-1). Therefore, it offers a solution for escape routes, underground structures, such as garages below the surface or a metro, meeting rooms, shopping malls or other places where a fire brigade requires usage of non-combustible insulation materials only.

Among the other advantages, we can include:

- ❑ The insulation is dry during its lifetime. There is no increase in the thermal conductivity of the insulation because the only condensed water vapour is in the wick. Normally, the wick is 40 to 50 % saturated.
- ❑ No glue is needed. The vapour retarder jacket joints are sealed by aluminium tape, it is not necessary to have an absolutely tight vapour barrier.
- ❑ The insulation can be installed directly on wet piping in operation. A cooling plant does not have to be turned off during installation.

CONCLUSION

The self-drying insulation has successfully been demonstrated to work to prevent the accumulation of moisture in glass wool insulation for below ambient insulation systems. The fabric wick absorbs the condensed water and capillary forces induce transport to the evaporation area from where it dries into the ambient air.

The experiment has shown that the weight gain measured was confined to the wick material, which means that the insulation remains dry and, thus, maintains its initial thermal conductivity. The amount of moisture in the wick was less than 50 % of the moisture content when the wick was saturated. The experiment was conducted with ambient conditions at 75 % RH and a temperature up to 25 °C. If the ambient conditions are hotter and more humid, it may be necessary to seal the evaporation area with perforated tape to slow down the diffusion towards the cold pipe [3].

The recommended position for the pipe section is a slot-down configuration, but the experiment showed that the system also works in a slot-up configuration. The reason is that the capillary suction forces of the glass fibre fabric are strong enough to suck the moisture without the help of gravity. The drying ability is several hundred times larger than the moistening speed even with a somewhat damaged surface or less careful workmanship as the experiment with a pipe section without a vapour retarder jacket proved [3].

Contact: vit.kov@email.cz

References

- [1] EN ISO 15758:2014. Hygrothermal performance of building equipment and industrial installations – Calculation of water vapour diffusion – Cold pipe insulation systems.
- [2] KOVERDYNSKY, V. *Self-Drying Insulation – Wick-Concept Insulation for Cold Piping*. LAP LAMBERT Academic Publishing, 2010, p. 148. ISBN-13: 978-3-8433-7062-2.
- [3] KOVERDYNSKY, V., KORSGAARD, V., CARSTEN, R. The Wick-Concept for Thermal Insulation of Cold Piping. *Journal of Building Physics*. 2006, Volume 29, NO. 4, pp. 313-327. SAGE Publications: London. ISSN 1744-2591.

Ing. Erika LANGEROVÁ
Ing. Roman VAVŘIČKA, Ph.D.
Ing. Vojtěch ZAVŘEL, Ph.D.

CTU in Prague, Faculty of
Mechanical Engineering,
Department of Environmental
Engineering

Combined space and water heater performance analysis

Analýza provozu ohřivače pro přípravu teplé vody a současnou podporu vytápění

This paper presents the results of a combined space and water heater simulation analysis. An analysis was performed for an out-of-the-box water heater integration into the combined space and water heating system. Model of the combined system was built, and a simulation analysis was performed in TRNSYS. The quality of the water heater simulation model was verified against the manufacturer's data and draw-off and performance tests were performed.

Keywords: domestic hot water, space heating, water heater, water heater draw-off tests, DHW draw-off profile

Článek představuje výsledky simulační analýzy provozu zásobníkového ohřivače pro kombinovanou přípravu teplé vody a vytápění. Analýza byla provedena pro atypický koncept zapojení ohřivače. Pro účely simulační analýzy byl sestaven model řešeného systému v prostředí TRNSYS. Kvalita nastavení modelu ohřivače byla ověřena proti experimentálním datům od výrobce a následně byly provedeny zátěžové a provozní testy ohřivače.

Klíčová slova: teplá voda, vytápění, ohřivač teplé vody, zátěžové testy zásobníku teplé vody, odběrový profil teplé vody

INTRODUCTION

The aim of this article is to present a combined space and hot water heating system with an out-of-the-box integrated heater. The heater is connected in such way that hot water is supplied directly to the fixtures and the energy for the space heating system is supplied indirectly by means of an external plate heat exchanger. This concept of a water heater integration to the system is mainly used in the USA and Canada in combination with hydronic space heating (Fig.1) [1] or with an air handling unit, but it is not yet widespread in Europe. It is intended for buildings with a low space heating demand and a high domestic hot water demand. The simulation analysis was focused on testing the draw-off characteristics of the combined water heater when supplying energy simultaneously to both connected systems. Discharge tests were performed, and the water heater performance was tested under various domestic hot water (DHW) draw-off profiles. The main objective of the paper is to introduce the reader to a non-conventional system that could be applied in buildings with high hot water demands.

WATER HEATER INTEGRATION CONCEPT

A combined DHW and space heating system according to Fig. 1 is considered. A directly heated gas-fired water heater with a modulating

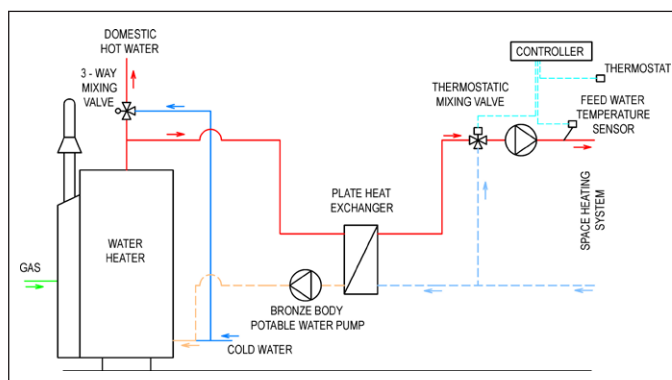

Fig. 1 Combined space and water heater used with a hydronic heating system

burner is used as the heat source. The water heater is integrated to the system in such way that it supplies DHW directly and the energy for the space heating is supplied indirectly via an external counterflow plate heat exchanger. The DHW is mixed with cold water in a thermostatic mixing valve to the required outlet temperature. A variable speed pump is installed in the secondary space heating circuit. A DHW priority control is not used, the water heater supplies energy simultaneously to both connected systems when needed.

SIMULATION MODEL IN THE TRNSYS SOFTWARE

A water heater installed in a car wash station was simulated. This scenario represents a facility with a negligible space heating demand relative to the DHW demand. A carwash station equipped with three covered bays and a heated unit for employees was considered. The TRNSYS simulation software was used to model the system performance, see Fig. 2 for the system model. The directly heated water heater is represented by a Type 158 module. The water heater charging is controlled by a Type 106 module, which monitors the temperature at the thermostat and generates a signal to start the charging process if necessary. Module 4 contains equations that simulates a modulating burner. The water heater output is modulated linearly depending on the outdoor temperature. The outdoor temperature is fed into Module 4 from a Type 15 module, which contains the weather data. DHWcalc [2] software was used to generate the DHW load profiles. A Type 9c module is used to load the DHW profiles into the TRNSYS software. To simulate the mixing valve operation, a Type 11f module is used as a diverting valve, a Type 11d module is used as a mixing valve and a Type 115 module is used as a controller. Type 11f and Type 11d modules are used to simulate the mixing valve in the primary space heating circuit. The mixing ratio is calculated by the weather compensation controller Module 1 and fed to a Type 115 module, which controls the mixing process. The hot water circulation in the primary heating circuit is maintained by a constant speed pump. The heat exchanger, a Type 5b module, is used to transfer the heat from the primary to the secondary space heating circuit. A variable speed pump is used to maintain the circulation in the secondary space heating circuit. The pump speed is controlled by a PI controller. A Type 1231 module rep-

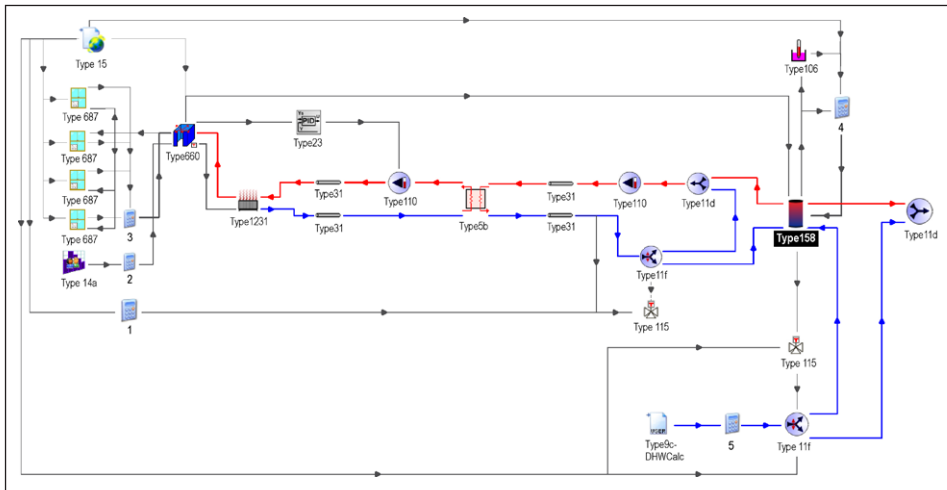

Fig. 2 TRNSYS simulation model

The charging test was performed by charging the water heater volume from an initial temperature of 10 °C to the final temperature of 85 °C. The temperature was monitored at a thermostat located at 3/4 of the tank height. The simulation results compared with the manufacturer's control points are shown in Fig. 3. The results show a sufficient match between the model and the real-world water heater performance. The draw-off test was used to evaluate the model quality by means of a continuous DHW supply. According to the manufacturer, the water heater can deliver a continuous DHW flow rate of $q = 500$ l/h, 540 l/h and 620 l/h at a mixing temperature $t_{MIX} = 65$ °C, 60 °C and 54 °C, respective-

resents the hydronic floor heating system. The building is represented by a simplified single zone Type 660 module and the building windows are represented by a Type 687 module. Both types are referred to Type 15 modules to receive the outdoor temperature and the incident solar radiation. A variable building occupancy profile is modelled by a Type 14a module. It is assumed that one employee is permanently present in the facility every day between 7:00 and 16:00. The main parameters of the building and water heater are given in Table 1.

Tab. 1 The main parameters of the building and water heater

Building location	Prague
Heated floor area	67 m ²
Glazing percentage	7 %
Total heat loss coefficient	95 W/K
Rated water heater power	31 kW
Water heater volume	380 litres

WATER HEATER MODEL – QUALITY CONTROL

To check the quality of the water heater model settings, two control tests were performed, and the results were compared with the manufacturer's experimental data. The following tests were performed:

- Charging test
- Draw-off test

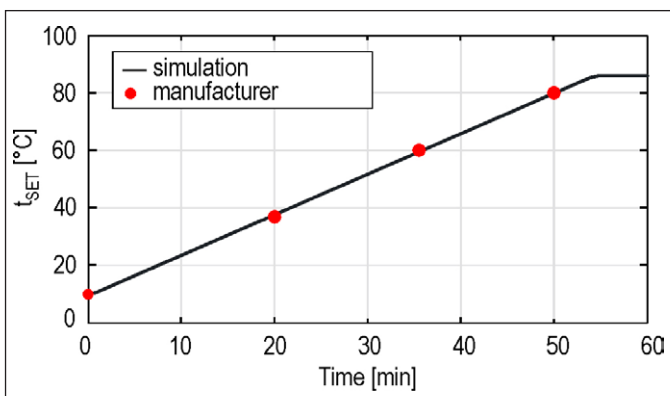

Fig. 3 Water heater charging characteristics compared to the manufacturer's control points

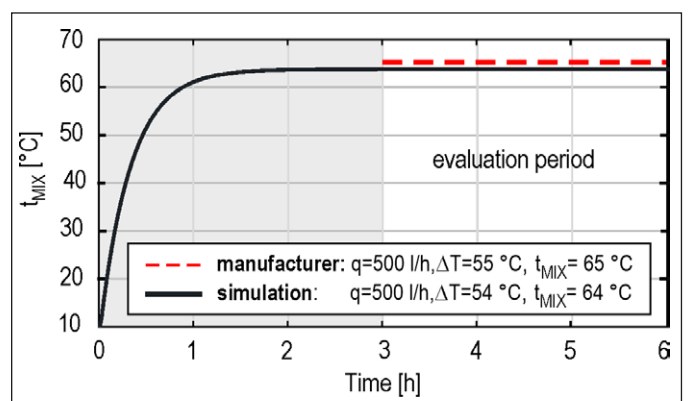

Fig. 4 Water heater draw-off characteristics - flowrate 500 l/h

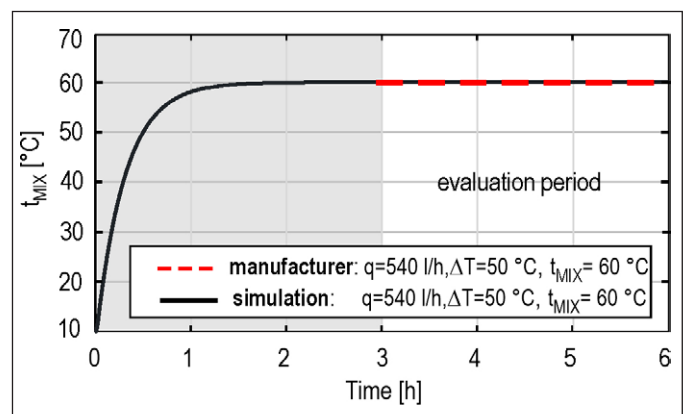

Fig. 5 Water heater draw-off characteristics - flowrate 540 l/h

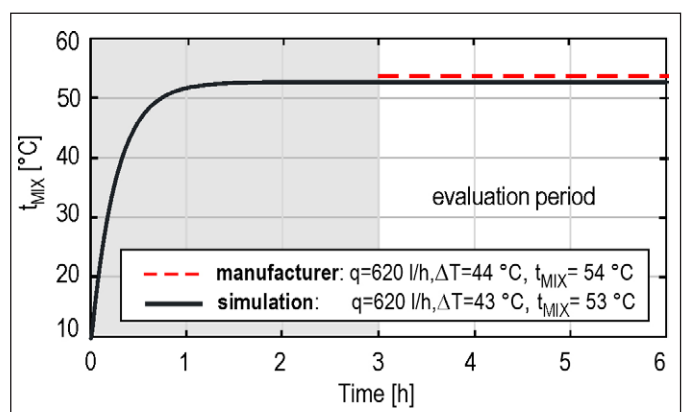

Fig. 6 Water heater draw-off characteristics - flowrate 620 l/h

ly. The initial temperature of the whole water heater volume was set to 10 °C and the flow rate was set to the required value as listed above. Firstly, the volume was charged to the required temperature difference $\Delta T = 55\text{ °C}$, 50 °C and 44 °C and the ability to supply hot water continuously was evaluated after the temperature on the thermostat had stabilised at the required value. The simulation results compared with the manufacturer's data are shown in Figs. 4 to 6. The results show a sufficient match between the model and the manufacturer's data. It must be noted that during these tests, no hot water was supplied for the space heating.

WATER HEATER CAPACITY AND PERFORMANCE ANALYSIS

Water heater discharge test

Discharge tests were performed to determine the capacity of the water heater to meet the DHW peak demand when simultaneously supplying energy for the space heating. The discharge test indicates how long the heater can cover the DHW peak demand before the temperature falls below the desired value.

The discharge tests were performed from a fully charged volume and with a rated space heating demand. The required outlet temperature at the DHW mixing valve outlet was fixed and the DHW flow rates were gradually changed. The time for which the heater can maintain the required outlet temperature at the DHW mixing valve outlet at a given DHW flow rate while simultaneously covering the space heating demand was monitored. The test provides an indicator of the water heater's ability to cover the peak demand at different loads from both systems. The water heater power is not modulated during the test so that the rated power is delivered. An illustrative example of the test result is shown in Fig. 7. A 50 °C temperature was required at the thermostatic mixing valve outlet. The results show that the heater is capable of continuously supplying any hot water demand at 50 °C with flow rates lower than 9 l/min. This is the equivalent of two simultaneous showers, or a simultaneous low-flow bath and shower. The water heater will be able to cover a 33 l/min peak flow for a maximum of 5 minutes before the DHW temperature at the mixing valve outlet drops below the required 50 °C. This chart can be used as a practical guide for the combined water heater sizing.

The importance of the hot water load profile and its relevance to the discharge tests

The results from the discharge test allow a quick decision to be made as to whether the heater is suitable for the application at hand. Two different DHW load profiles were used to demonstrate the relationship between the water heater performance and its discharge characteristics. The profiles were intentionally set up to draw the same total DHW volume, but with different draw-off patterns. In the case of the first load profile, AMEXT1, the DHW flow rates were intentionally set very low, with a peak flow rate of a max. 6 l/min, see Fig. 8. This represents the typical flowrate in portable domestic car washing stations or wash basins. In the second load profile, AMEXT2, the flow rates were set significantly higher,

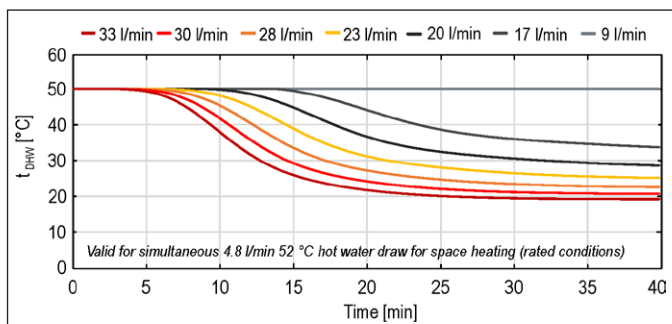

Fig. 7 Discharge test for the simultaneous space and DHW delivery

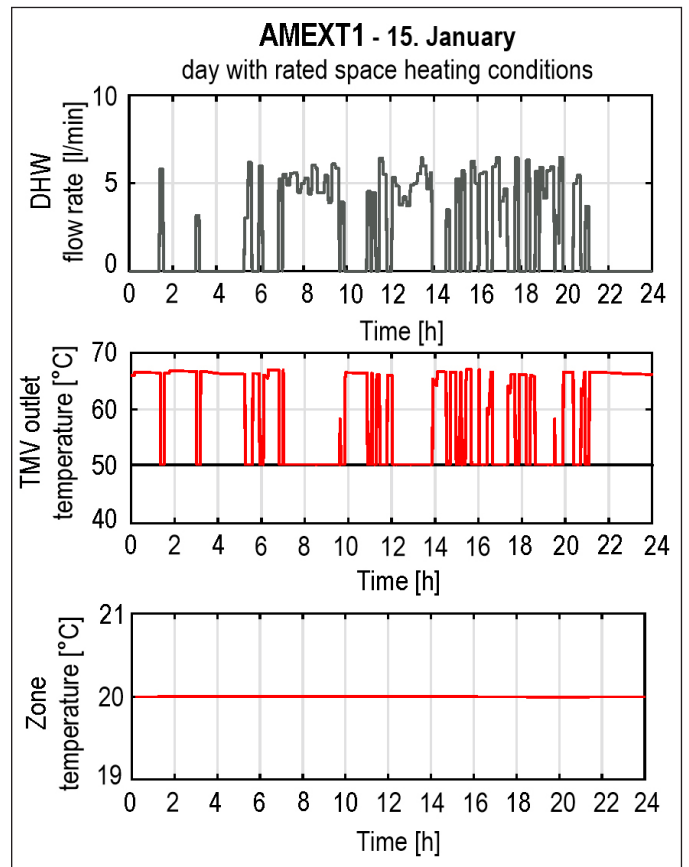

Fig. 8 DHW flow rates and test results for the AMEXT1 load profile

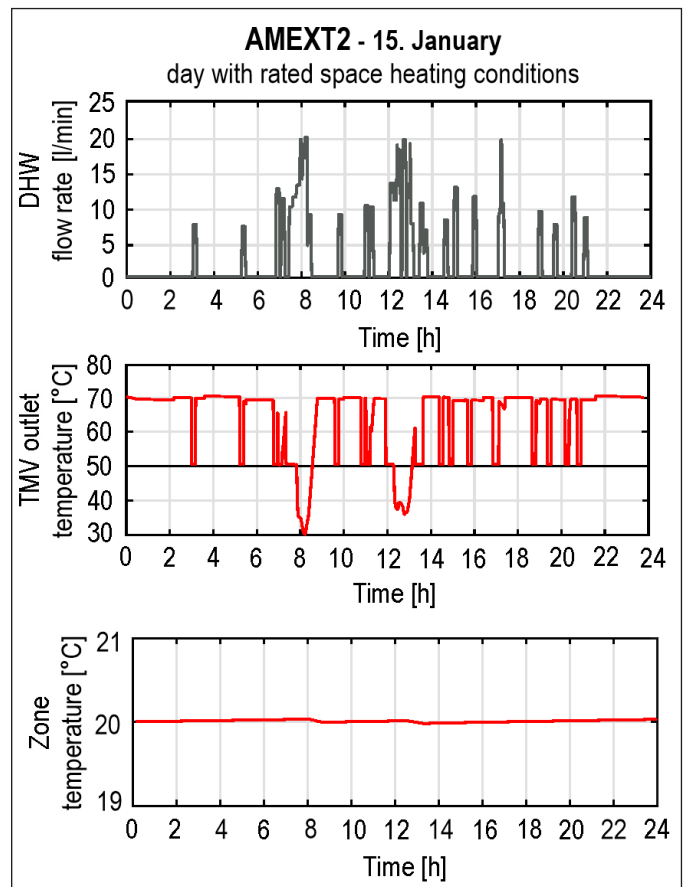

Fig. 9 DHW flow rates and test results for the AMEXT2 load profile

with a peak flow rate of a max. 20 l/min, see Fig. 9. This represents the typical flow rate in commercial car washing stations or luxury baths. Regarding the space heating, rated flow rates and temperatures were required for both cases.

Although the tapping peaks last for a much longer period in the first load profile, AMEXT1, the DHW temperature at the mixing valve outlet did not drop below the required 50 °C (the required temperature level is indicated by the black line in the graph). This is due to the low flow rate. However, due to the high flow rate in the AMEXT2 load profile, the DHW temperature dropped below the required value in several cases. This is even though the peak loads lasted a significantly shorter time than in the AMEXT1 load profile. When comparing the peak flows and their duration in the load profiles in Fig. 8 and Fig. 9 with the graph from the water heater discharge test in Fig. 7, the time for which the heater can deliver such high flows has been significantly exceeded in the case of AMEXT2.

This indicates that it is not the total amount of hot water withdrawn per day that is critical for sizing the water heater, but the pattern of the individual draws. When sizing a water heater, emphasis should be placed on the correct determination of the DHW load profiles on site, i.e., the combinations of the peak flow rate, load duration and required temperature during the draws. This should be compared with the discharge tests for the chosen heater.

Another interesting finding from the test is the effect of the short-term storage tank outlet temperature drop on the temperature in the heated zone. Although the DHW temperature in the AMEXT2 profile temporarily dropped below the required value in several cases, the temperature in the zone was not affected due to the thermal capacity of the building. It should be noted that the simulation model did not account for the effect of the heating surface inertia.

An evaluation of the heating surface inertia in relation to the performance of heat sources with an indirectly heated water storage tank can be found, e.g., in [3]. For a hydronic floor heating system with wet flooring, the cool-down inertia is stated to be a few hours, so it would be possible to stop the supply to the space heating system within the DHW peak for 30 to 40 minutes without affecting the temperature in the heated zone. The same applies to the use of, e.g., cast iron radiators where a heat supply shortage for 10 to 20 minutes would likely not affect the temperature in the zone. In the case of stainless-steel radiators, it would be possible to shut down the space heating system for 5 to 10 minutes without affecting the zone temperature. However, even this short-term energy supply shortage could increase the heater capacity to cover the ongoing DHW peak demand. This would essentially be the principle of the DHW priority control.

CONCLUSION

The paper presented a non-conventional concept for the hot water heater integration into a combined space and DHW heating system. The aim of the paper was to test the capacity and performance characteristics of the selected heater by means of a simulation study. The capacity was determined by means of a discharge test, from which water heater ability to cover different peak loads can be easily read. In further tests, it is expected that we can verify the simulation results through experimentation. Discharge tests will be performed for different load combinations and the results will be generalised. The generalised results will be used as a guide to size the combined heaters. From a control point of view, the potential to use the thermal capacity of the building and heating surfaces for the short-term shutdown of the heating system supply and

to increase the potential for covering the DHW peak loads will be further discussed in the follow-up analyses.

Contact: erika.langerova@fs.cvut.cz

References

- [1] SIEGENTHALER, J. *Modern hydronic heating for residential and light commercial buildings*. Clifton Park, NY: Delmar Cengage Learning, 2012. ISBN-13: 978-1428335158
- [2] JORDAN, U. a VAJEN, K. *DHWcalc: Program to generate domestic hot water profiles with statistical means for user defined conditions*, 2005. [online]. Universität Kassel. Available at: citeseerx.ist.psu.edu/viewdoc/summary?doi=10.1.1.560.350
- [3] VAVŘIČKA, R. *Tepelné čerpadlo a příprava teplé vody*. Topin [online]. 2015. Dostupné z: <https://www.topin.cz/clanky/tepelne-cerpadlo-a-priprava-teple-vody-detail-3481>

Abbreviations used:

DHW - domestic hot water

TMV - thermostatic mixing valve

AMEXT1 – Domestic hot water load profile 1

AMEXT2 – Domestic hot water load profile 2